

## Basin-wide data assimilation of SWOT observations: Initial results

K. Andreadis<sup>1</sup> D. Moller<sup>2</sup> E. Rodriguez<sup>3</sup> P. Bates<sup>4</sup> M.  
Durand<sup>1</sup> D. Alsdorf<sup>1</sup> D. Lettenmaier<sup>5</sup> B. Sanders<sup>6</sup>

<sup>1</sup>Ohio State University

<sup>3</sup>NASA JPL

<sup>5</sup>University of Washington

<sup>2</sup>Remote Sensing Solutions Inc.

<sup>4</sup>Bristol University

<sup>6</sup>University of California-Irvine

OST-ST Meeting 2010, Lisbon

- SWOT *direct* observations will include **water surface elevations, widths and slopes**
- Discharge is very important for hydrology
- Direct estimation of discharge through Manning's equation can be difficult
- Models can predict discharge, but impeded by significant errors
  - Forcings (e.g. precipitation, boundary inflows)
  - Model parameters (e.g. channel characteristics)

- SWOT *direct* observations will include **water surface elevations, widths and slopes**
- Discharge is very important for hydrology
- Direct estimation of discharge through Manning's equation can be difficult
- Models can predict discharge, but impeded by significant errors
  - Forcings (e.g. precipitation, boundary inflows)
  - Model parameters (e.g. channel characteristics)
- Merging SWOT observations with modeling predictions via data assimilation
- Developing and testing of SWOT assimilation framework for discharge estimation

# How to test the algorithms?

- “Virtual” SWOT observations
- Identical twin synthetic assimilation experiment

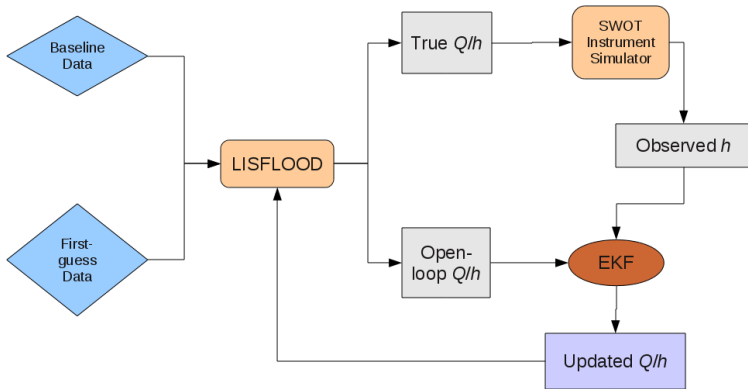

- A number of simple data assimilation experiments in different study areas
- Amazon River basin
  - 240 km reach
  - Relationship between inundated area and slope
  - Estimated WSE and bathymetry at selected locations
- Ob River basin
  - Estimated water depths
  - Model errors in precipitation and temperature
  - Demonstrated effects of localization in assimilation
- Ohio River basin
  - 50 km reach
  - Assimilation of SWOT WSE to estimate river discharge
  - Examined sensitivity to observation error and temporal persistence of analysis

# Previous work - WSE

- Estimated river channel discharge and water depth after assimilating synthetic WSE observations
- True and Observed WSE
- Differences of Open-loop and Assimilated WSE, from the True WSE

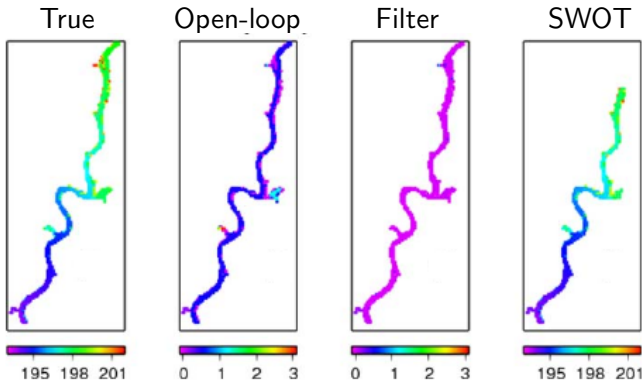

# Previous work - Discharge

## Along-channel discharge

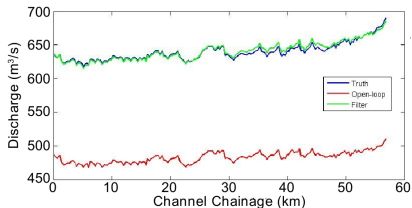

## Downstream discharge

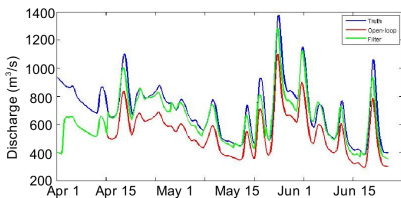

## Discharge error time series

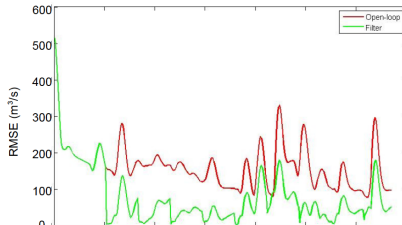

## Previous work - Limitations

- Model errors came only from boundary inflows
- Uncertain knowledge of channel characteristics (bed elevation, roughness etc.)
- Synthetic SWOT observations generated by adding white noise ( $\sigma = 50\text{cm}$ ) to “true” WSEs
- Needed an actual SWOT instrument simulator to produce synthetic observations with correct *orbital* and *error* characteristics
- Larger domain size simulations



# Study area

- ~1000 km reach of the Ohio River basin
- Drains an area of ~220,000 km<sup>2</sup>
- Topography from National Elevation Dataset (30 m)
- River topology from HydroSHEDS
- Channel width and depth from developed power-law relationships
- Modeled main stem with inflows from tributaries

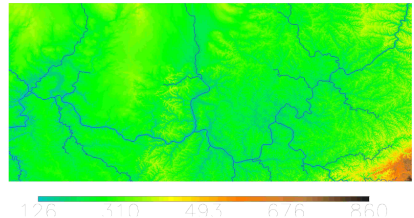
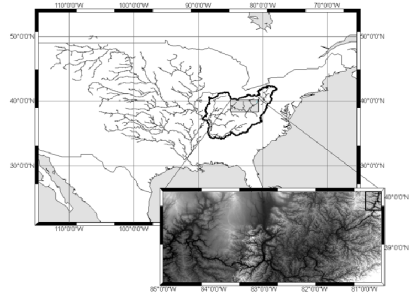

- LISFLOOD-FP raster-based hydrodynamics model
  - 1-D solver for channel flow
  - 2-D flood spreading model for floodplain flow
  - Kinematic, Diffusive and Inertial formulations
  - Requires information on topography, river channel characteristics and boundary inflows
- 
- Assumption of rectangular channel
  - Has been successfully applied in a number of river systems (mostly smaller scale)

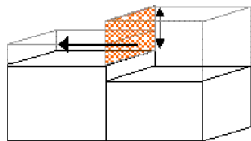
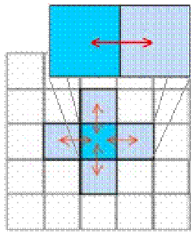

# SWOT simulator

- The Instrument Simulator calculates interferometric response from land and water
- Produces data with correct SNR, layover and geometric decorrelation scattering properties
- Thermal and speckle noise are added
- Media effects will be added (precipitation, wet tropospheric delay)

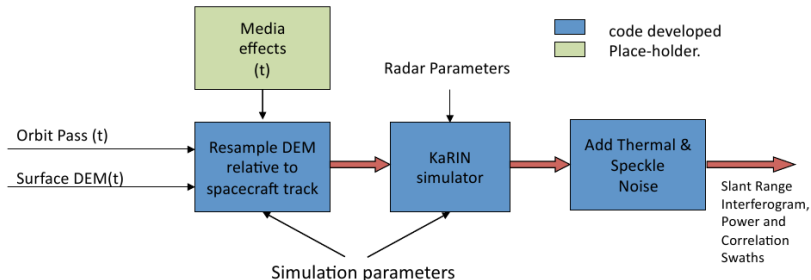

# SWOT simulator data processing

- Topographic layover and low land SNR make conventional phase unwrapping challenging
- Fringes are well defined over the water
- The signal from topography may contaminate the signal over the water
- Assuming a “reference” interferogram, a change in height can be estimated

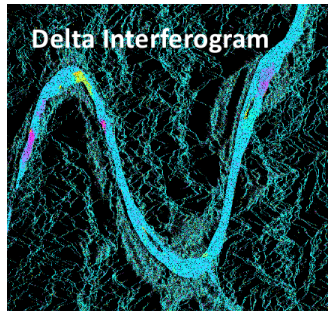
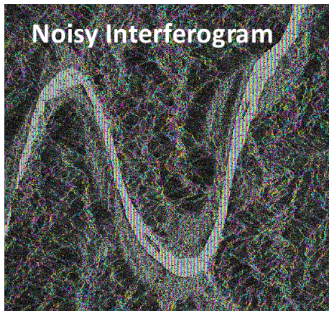

## Open-loop simulation

- 3-month simulations
- Boundary inflows taken from USGS gauge measurements
- Perturbed for “first-guess” using  $\hat{Q} = Q + N(0.2 Q, 0.3 Q)$
- Can examine impact of model errors in inflows and channel characteristics separately
- Channel width perturbed with 10% zero-mean Gaussian errors
- Channel bathymetry perturbed with Gaussian errors  $N(2.0\text{m}, 0.5\text{m})$
- Roughness coefficient assumed to be 0.042 (true value of 0.030)
- Three open-loop simulations (Q, wnz, wnz-Q)

# Data assimilation

- A number of assimilation techniques available
- Extended Kalman filter (EKF)
  - Requires explicit modeling of model error covariance, and tangent linear models
- Ensemble Kalman filter (EnKF)
  - Requires ensemble of model states
- EKF is used, estimating the model error covariances using the NMC method
  - assumes error correlations are similar to correlations of differences between successive forecasts
- Every SWOT pass is assimilated separately (filtering)
  - Smoothing could be done by assimilating observations for every orbit cycle

# Results - SWOT observations

Successive passes of  
a full orbital cycle

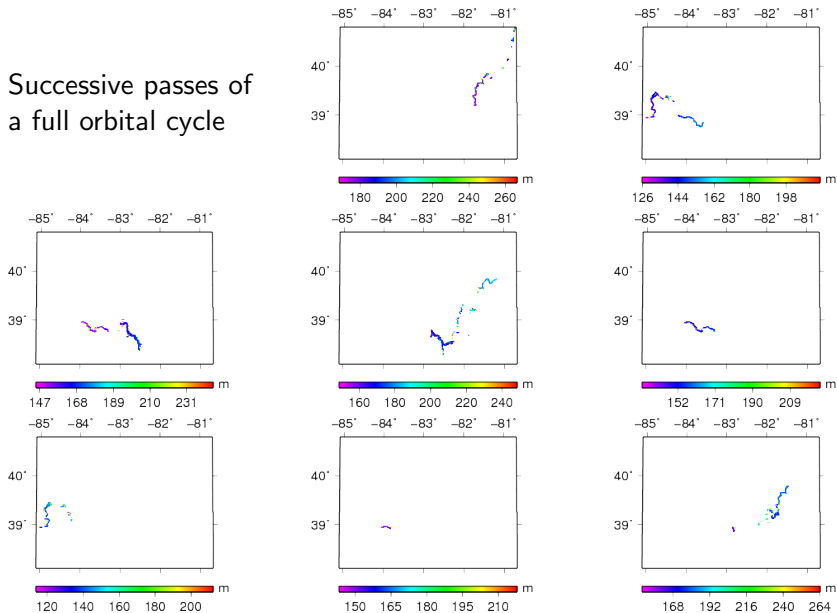

# Results - Open-loop simulations

- True water depth and differences of three open-loop simulations from truth

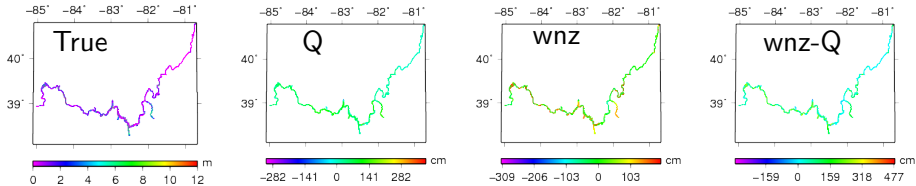

- Channel discharge for one time step
- Inflow error dominates simulated discharge
- Errors in channel characteristics play a less significant role

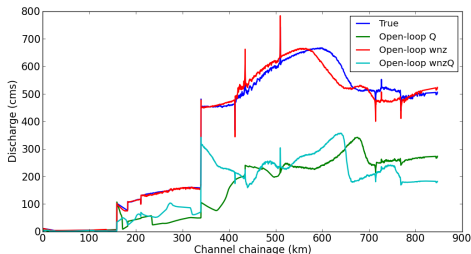



# Results - Q Simulation

- Errors only in boundary inflows
- Discharge and water depth for the three different simulations

March 30, 2010

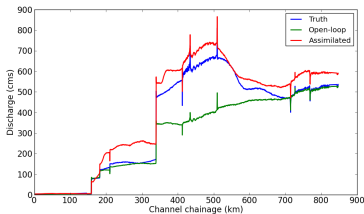

April 19, 2010

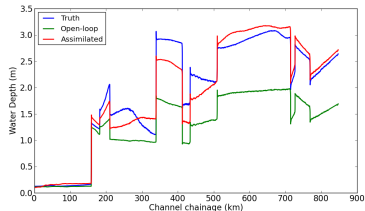
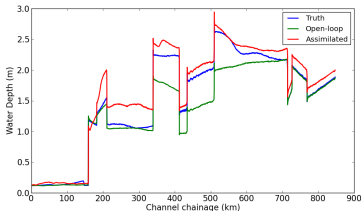
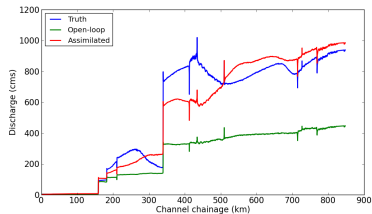

# Results - wnz Simulation

- Errors only in channel width, depth and roughness
- Discharge and water depth for the same SWOT overpasses

March 30, 2010

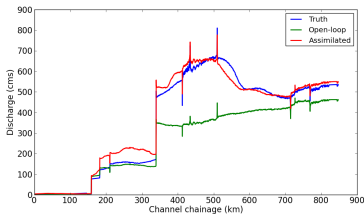

April 19, 2010

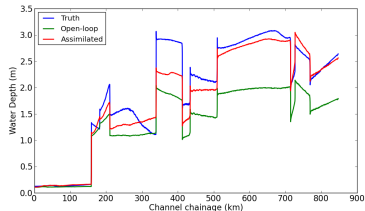
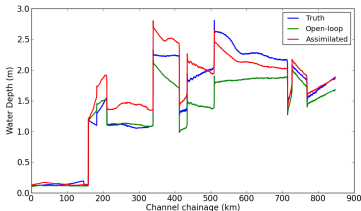
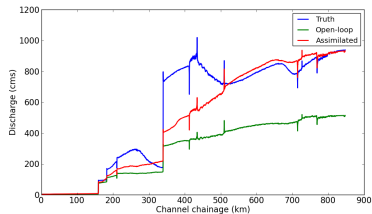

# Results - wnz-Q Simulation

- Errors only in inflows as well as channel characteristics
- Ingesting SWOT observed WSE results in improved discharge estimates

March 30, 2010

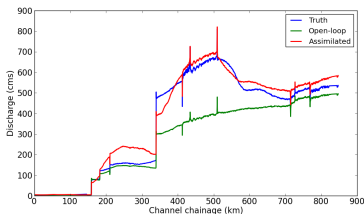

April 19, 2010

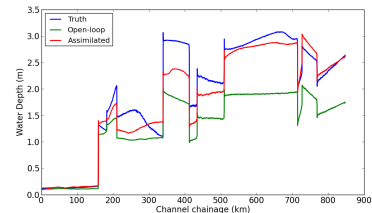
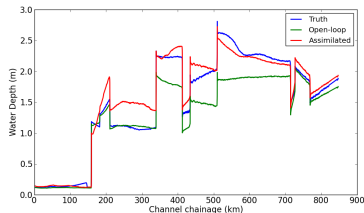
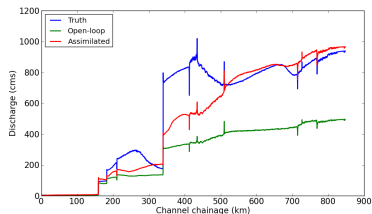

# Discharge error temporally

- Comparison of predicted discharge at study basin outlet
- Spatially averaged error along the river channel
- Assimilated discharge estimates are clearly better
- Issue with temporal persistence, related to inflow errors

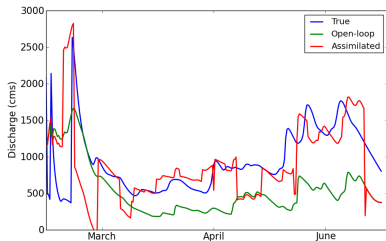

Downstream discharge

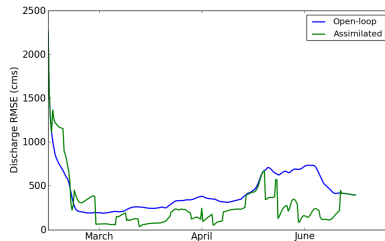

Discharge RMSE

# Results - Observation error

- SWOT WSE observations have an uncertainty estimate associated with each value
- During the assimilation, an estimate of that uncertainty is required
- We can assess the impact of different assumptions about the statistics of the observation errors

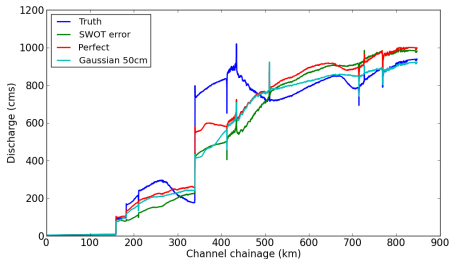
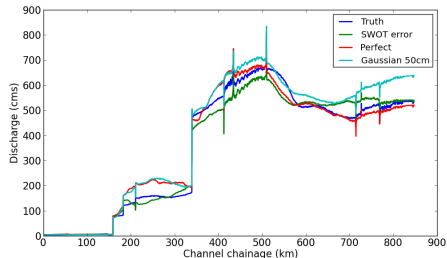

# Results - Spatial coverage

- SWOT will observe the entire domain over a number of passes during the 22-day orbital cycle
- How much is the estimation skill decreased when compared to observing the entire domain “at once”?
- The assimilation is mostly able to compensate for partial spatial coverage

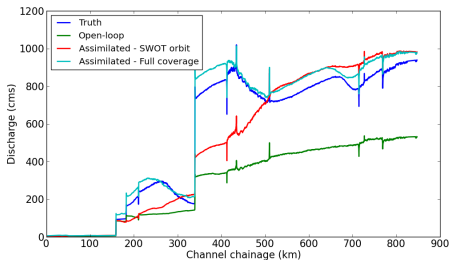
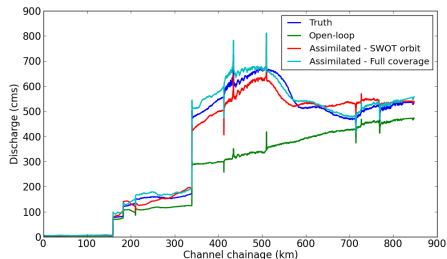

- Forward modeling (hydrodynamics) is computationally expensive
  - Multi-core/GPU computing
- Data assimilation algorithms
  - Can we afford ensemble-based approaches?
  - Variational assimilation
- Data processing
  - Very large volumes of data ( $\sim 50$  GB single SWOT cycle for the Ohio study area)
  - Massively parallel frameworks, e.g. Google's Map/Reduce or Hadoop
  - Different approaches for efficient storage and access (e.g. R-trees)

- Assimilation of SWOT observations overcomes errors in both inflows and channel characteristics
- Need extensive testing of different approaches in assimilating observations and modeling errors
- One important goal is creating algorithmic framework that
  - will be used for other study areas
  - can be released to the broader scientific community
- Assumptions for the observation errors, and the spatial coverage of SWOT do not appear to hinder discharge estimation



## Ongoing & future work

- Explicitly model tributaries
- Fraternal twin assimilation experiment
  - A full St. Venant equation solving model (BreZo) to represent “truth”
  - LISFLOOD as the core of the assimilation system
- Evaluate different assimilation techniques and error covariance modeling approaches
- Assimilate additional SWOT observables (top width, slopes)
- Evaluate information content of SWOT observations
  - Estimate river channel bathymetry
  - Calibrate hydrodynamic and hydrologic models