

# Satellite Altimetry

*Rosemary Morrow*

*Centre de Topographie des Océans et de l'Hydrosphère (CTOH)*

*Laboratoire d'Etudes Géophysiques et Océanographiques Spatiales (LEGOS)*

*Toulouse, FRANCE*

- Lecture 1. Principles of satellite radar altimetry
- Lecture 2. Ocean applications and extreme events
- Lecture 3. Coastal and operational applications
- Lecture 4. SWOT – Wide Swath altimetry



**Satellite Oceanography, CICESE, Ensenada. August 2008**

# *Laboratoire d'Etudes Géophysiques et Océanographiques Spatiales (LEGOS)*



4 agencies : **CNRS – CNES – University Toulouse III - IRD**  
50 permanent research staff – 20 PhD and Postdocs

## **Research groups :**

- Large-scale ocean dynamics and climate
- Coastal and offshore dynamics
- Satellite Continental Hydrology
- Satellite Glaciology
- Ocean dynamics and the carbon cycle
- Ocean tracers

**Sites :** Toulouse, Brest, Peru, Brazil, Noumea, Ivory Coast



**Satellite Oceanography, CICESE, Ensenada. August 2008**

### French observational service dedicated to satellite altimetry

#### Objectives:

- develop, maintain & distribute improved altimetric data
- validate & apply the most recent algorithms and corrections.
- user service : develop and distribute altimetric data products and aide research users
- centre of expertise for operational altimetric data centres (AVISO/CNES, ESA) for developing new products and new missions

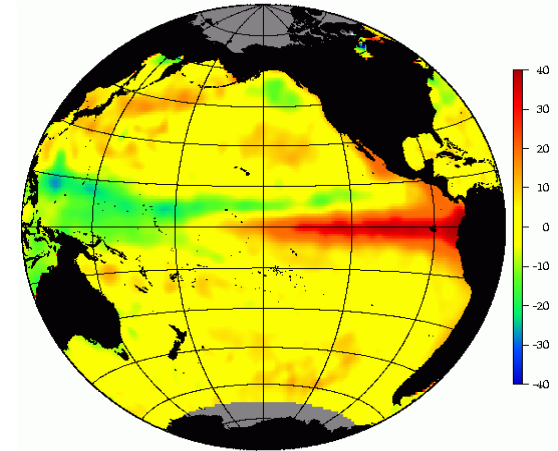

### Nouvelles applications altimétriques:

#### l'hydrosphère

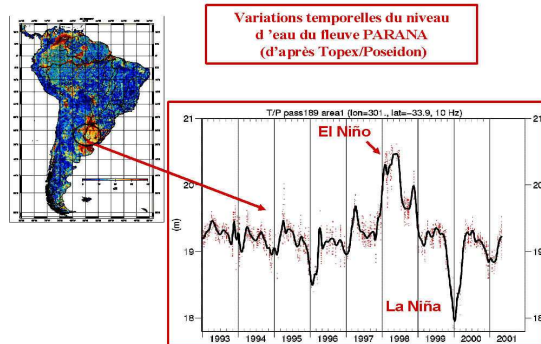

#### le côtier

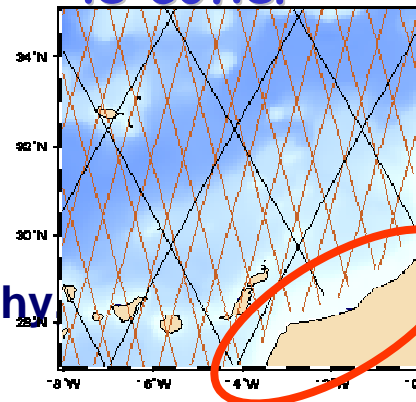

#### la cryosphère

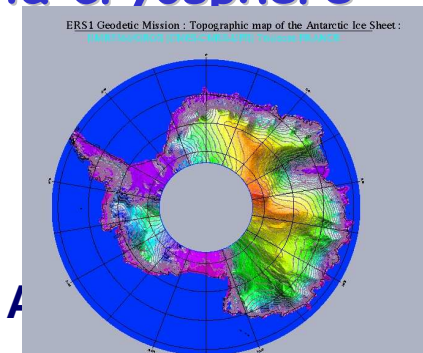

# Why use remote sensing to study the ocean ?

- The ocean covers 70% of the earth's surface
- 50% of the world's population live less than 100 km from the coast
- The ocean is a food source and an energy source
- The ocean is a slow but fundamental component of the earth's climate

Need to observe and monitor the ocean to understand its dynamics.



# The oceans modulate the climate

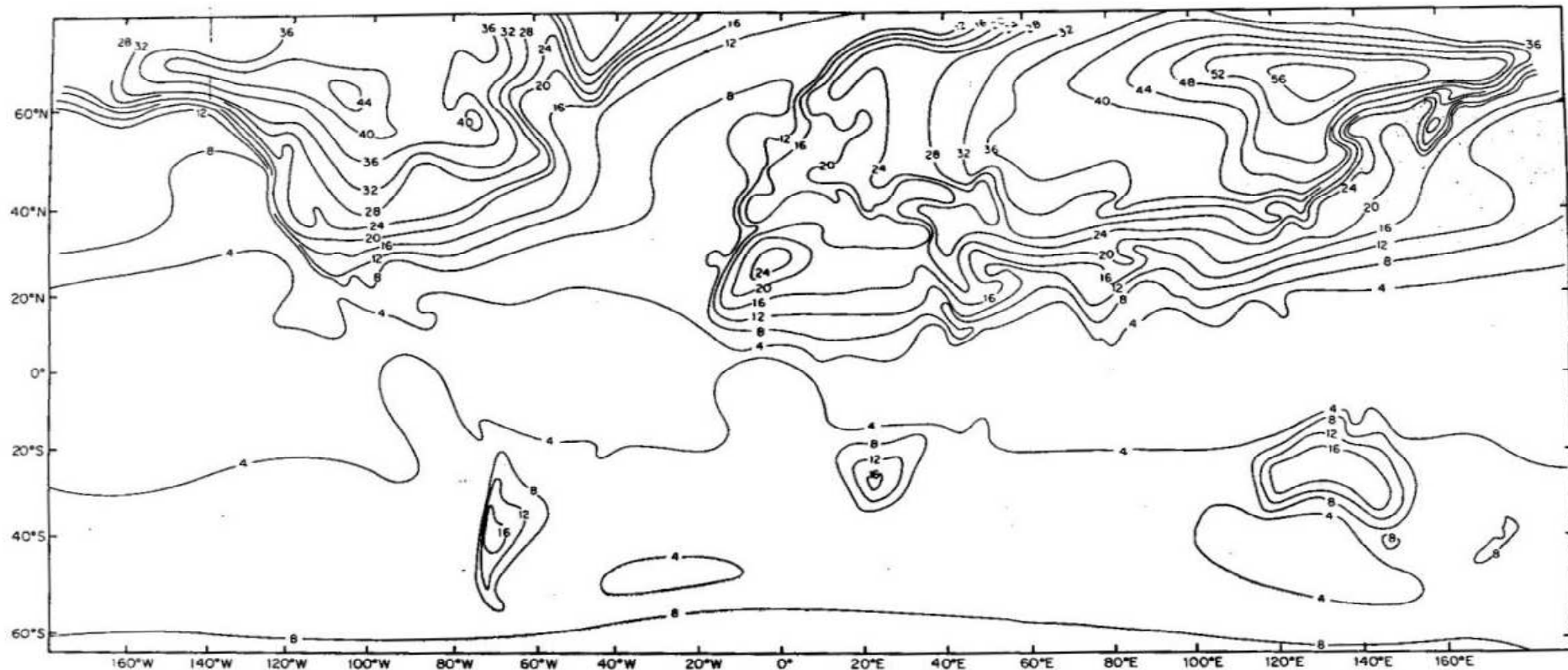

Fig. 2.1. Annual range of monthly mean temperatures at the earth's surface. [Adapted from Monin (1975, p. 203).]

**Figure : The annual range of monthly mean temperatures ( $^{\circ}\text{C}$ ) over the globe.**



**Satellite Oceanography, CICESE, Ensenada. August 2008**



## Water is a barrier to EM radiation

- Seawater inhibits the transfer of EM radiation  
(radio waves, microwaves, etc)
- Only acoustic waves propagate in the ocean interior
- The ocean's interior properties (  $u$ ,  $v$ ,  $T$ ,  $S$ ,  $\rho$  ) can only be measured in-situ

=> Remote sensing techniques are limited to the ocean surface



# Ocean observations

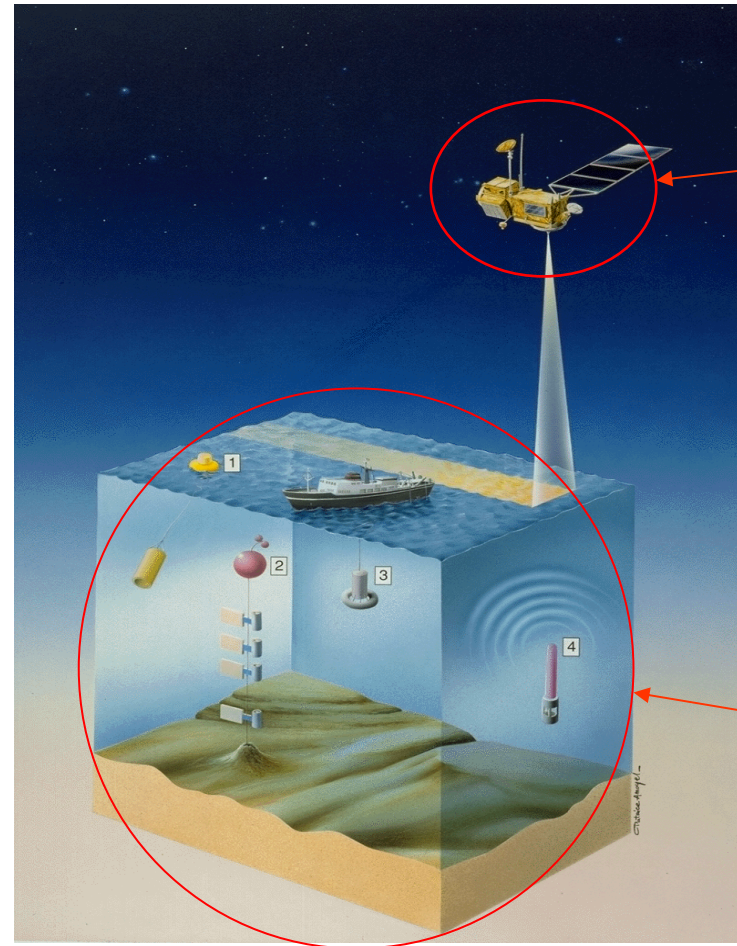

by satellite

by in-situ data



Satellite Oceanography, CICESE, Ensenada. August 2008

# In-situ measurements

- Spatial-temporal sampling is inhomogeneous
- Not adapted for long term ocean monitoring

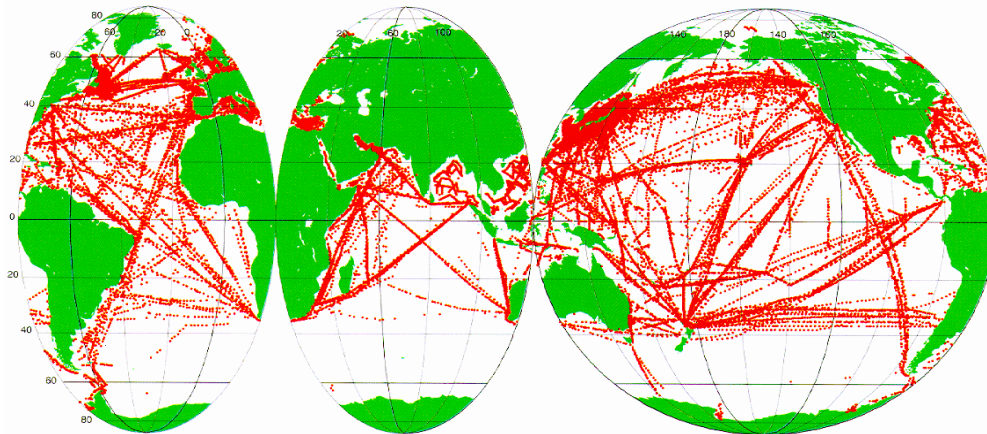

Locations of upper ocean thermal profiles collected during 1996.

## Maritime Routes

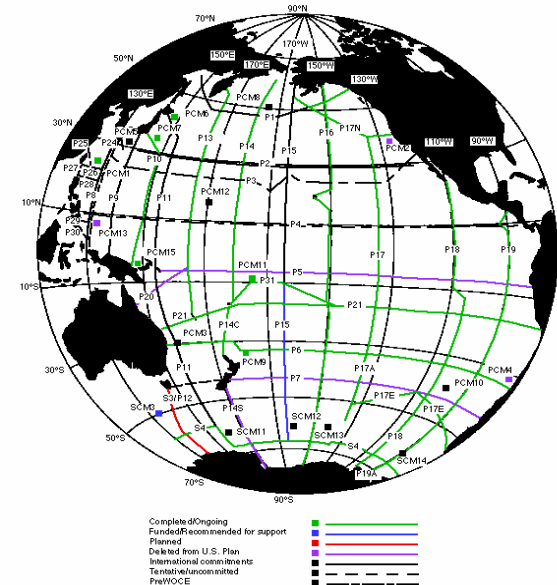

WOCE



Satellite Oceanography, CICESE, Ensenada. August 2008



# Satellite coverage

- Spatial coverage :
  - global
  - homogeneous
- Temporal coverage :
  - real-time
  - long term

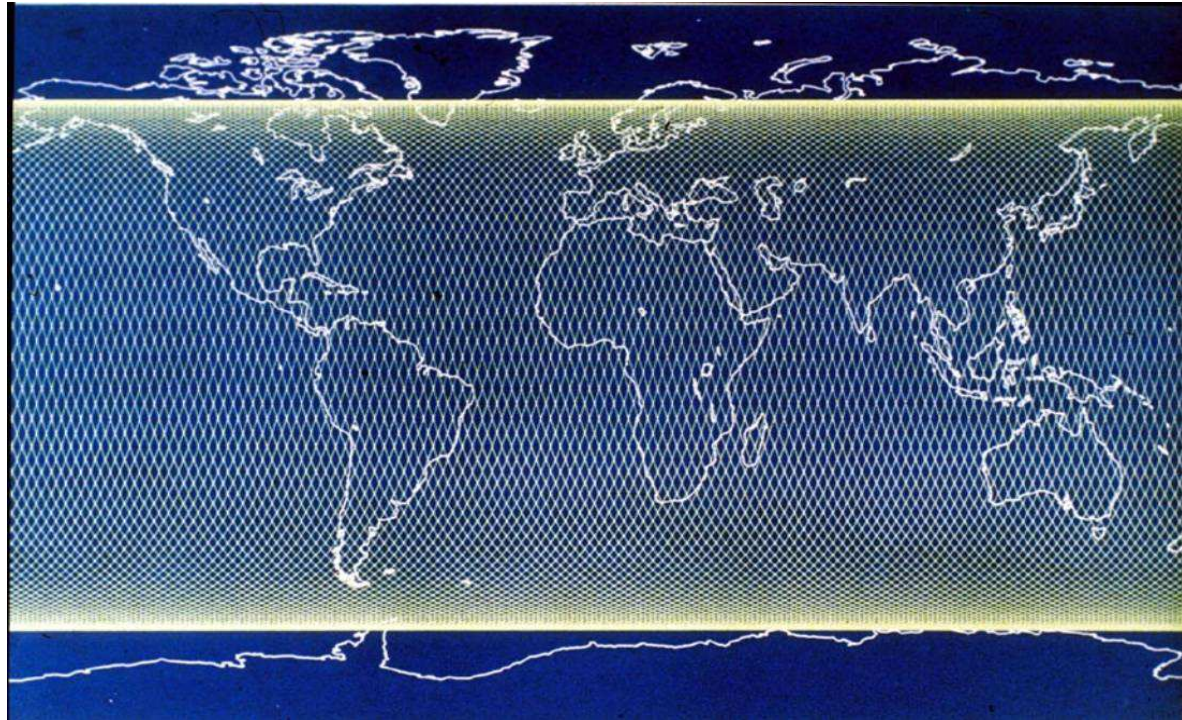

TOPEX/Poseidon Sampling



# Principles of radar altimetry ..

1

- Active radar sends a microwave pulse towards the ocean surface,  $c = 13.5 \text{ GHz}$  (T/P)
- Precise clock onboard measures the return time of the pulse,  $t$

$$t = 2d/c$$

**Centimetre Precision  
from an altitude of 800 – 1350 km**

- *Measures the backscatter power*
- *Measures sea level*
- *Measures ocean wave height*

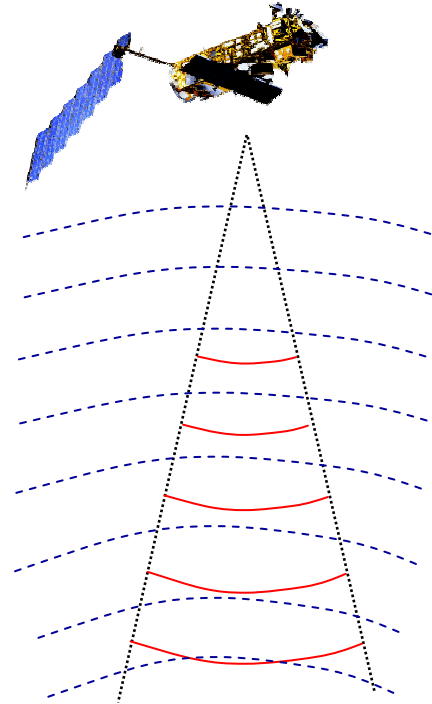

Distance,  $d$ , is also called  
the radar **RANGE**



# The Radar equation

The radar equation expresses the power of EM radiation received,  $P_r$ , which varies with :

- the wavelength,  $\lambda$ , of the pulse
- the antenna gain,  $G$
- the power emitted,  $P_e$
- the two-way atmospheric transmittance,  $T^2$ .
- the range from the target surface,  $R$
- the backscatter coefficient,  $\sigma$

$$P_r = T^2 P_e \frac{\lambda_0^2}{(4\pi)^3 R^4} G^2 \sigma$$

For a wide target (rough sea surface), the backscatter is calculated over the surface,  $S$ , illuminated by the antenna :

$$\sigma = \int_{\text{Surface}} \sigma_0 dS$$



# Choosing the frequency band

- International regulations
  - Science Objectives (rain, ocean, vegetation)
  - Technological constraints
- ↗ Precipitation rates  
 ↘ **Surface roughness**  
 ↘ Radar reflectivity ( $\phi$ , Fresnel)  
 ↘ Surface diffusion

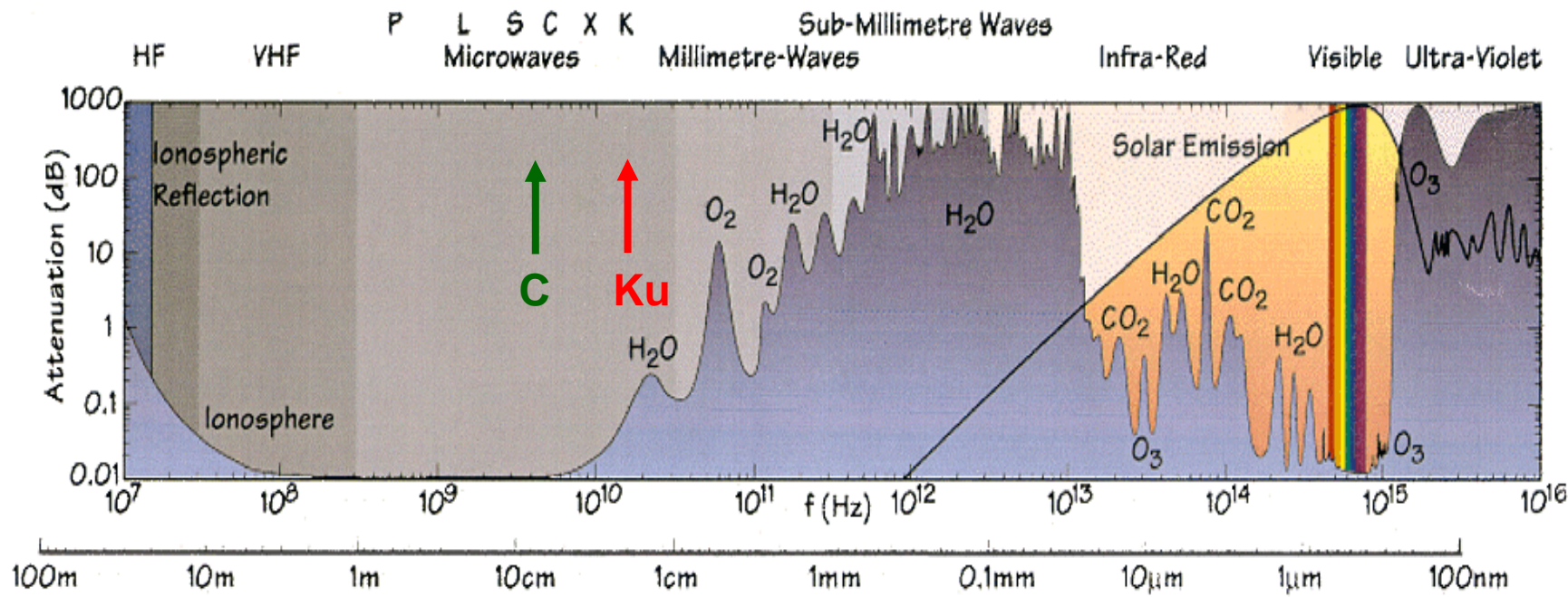



# Principles of radar altimetry

... 2

Precision of the range measurement depends on :

- an accurate satellite position
- various instrument errors
- various geophysical errors (e.g., atmospheric attenuation, tides, inverse barometer effects, ...)
- Resulting **sea surface topography** is a combination of ocean dynamic topography and the marine geoid.

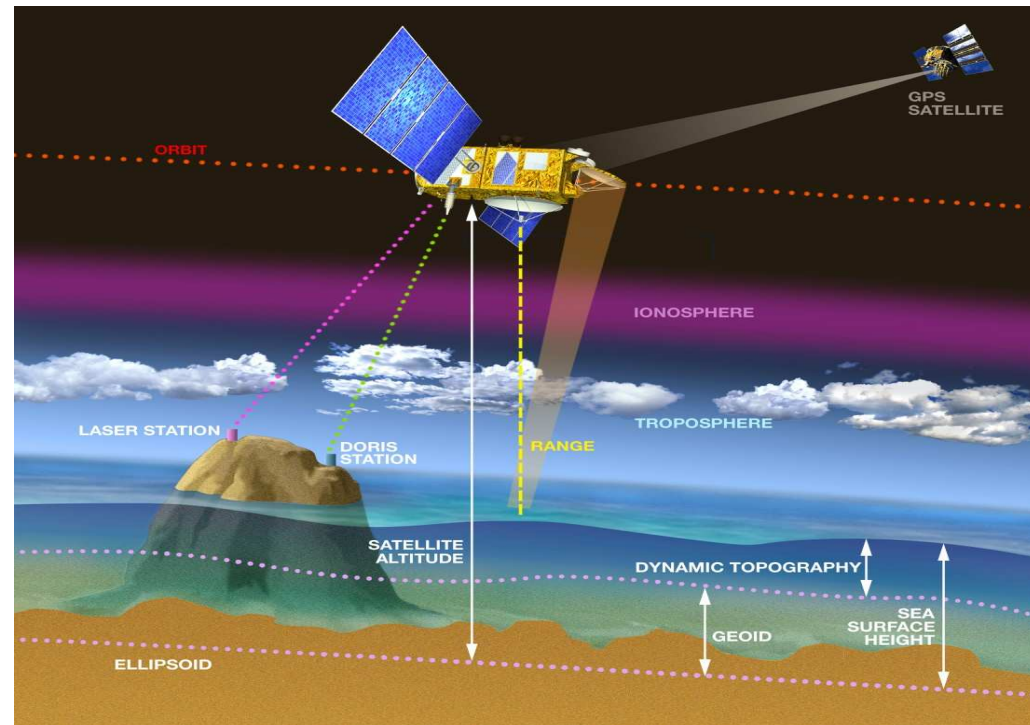



# Marine Geoid

The earth is non-spherical – flattened at the poles by the earth's rotation, it also has large bumps and troughs due to variations in the ocean bottom topography and inhomogeneous density distributions in the earth's interior.

These internal density variations create a bumpy gravity field : the geoid.

Marine geoid can be modelled with a good accuracy at large spatial scales (> 500 km wavelength) but it is not well known at small spatial scales.

Local errors in the marine geoid can reach 2m, over steep bathymetric features.

Geoid is near-stationary on oceanographic time-scales : by differencing data along exactly repeating satellite tracks we remove the geoid and its errors.

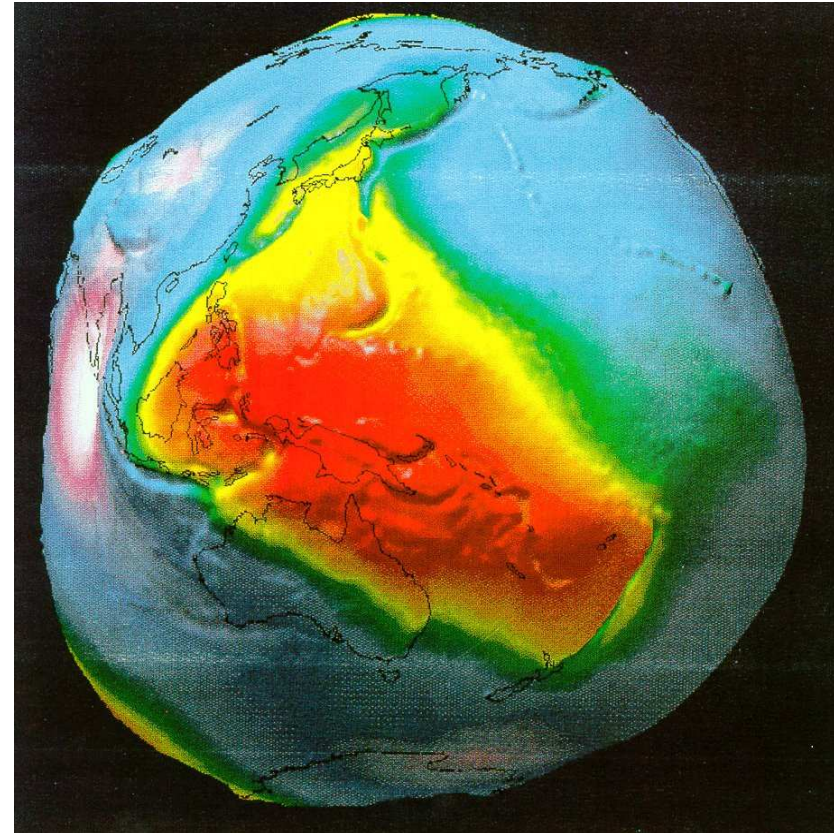

Geoid varies by –100 to 60 m.



# Marine Geoid and bathymetry

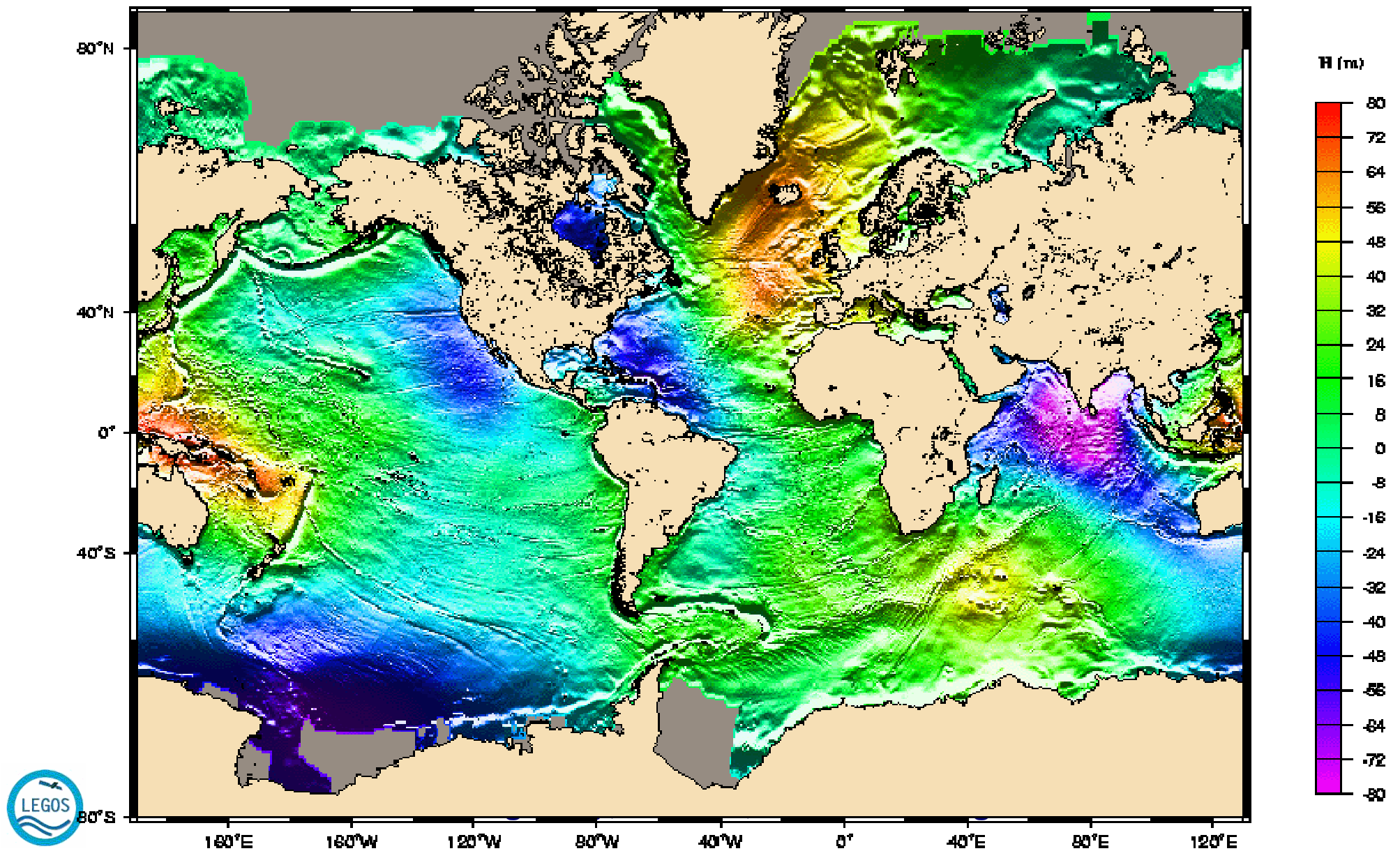

# The radar altimeter wave

form

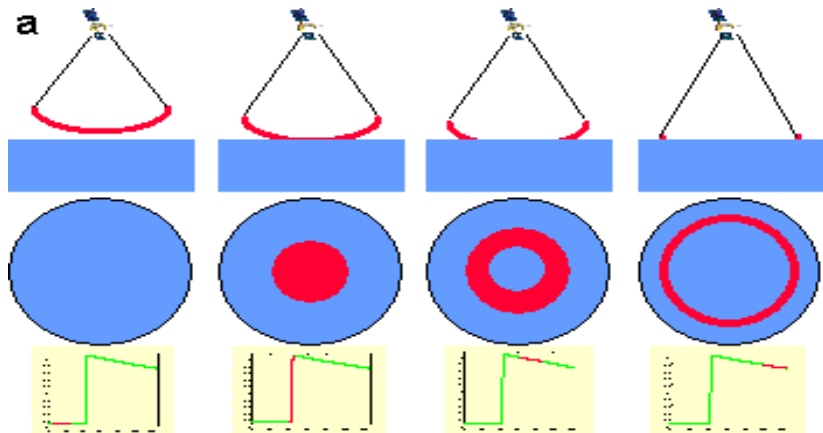

Ideally calm sea

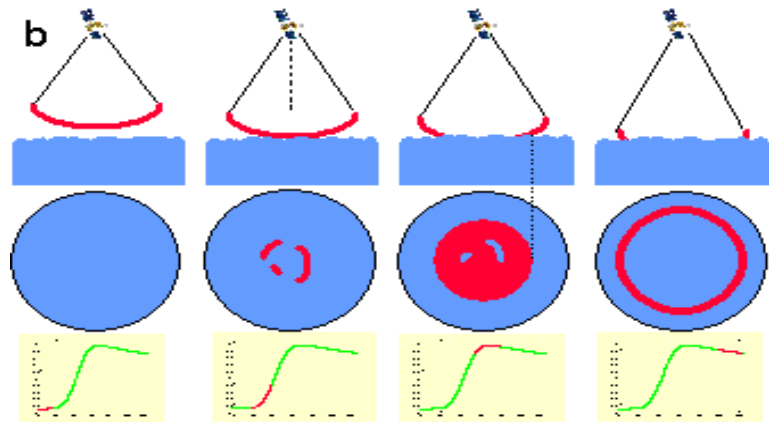

Rough sea

Green :  
Individual  
return pulse:  
  
Red :  
Average of  
90 return  
pulses

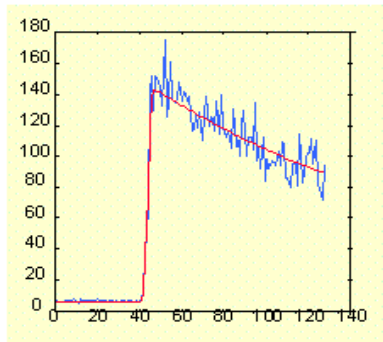
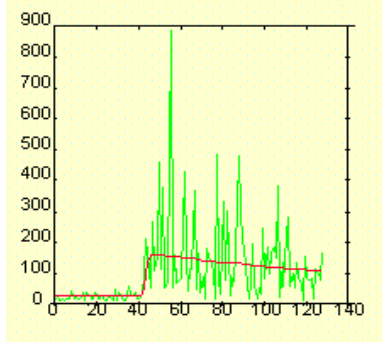

# Physical parameters from the waveform

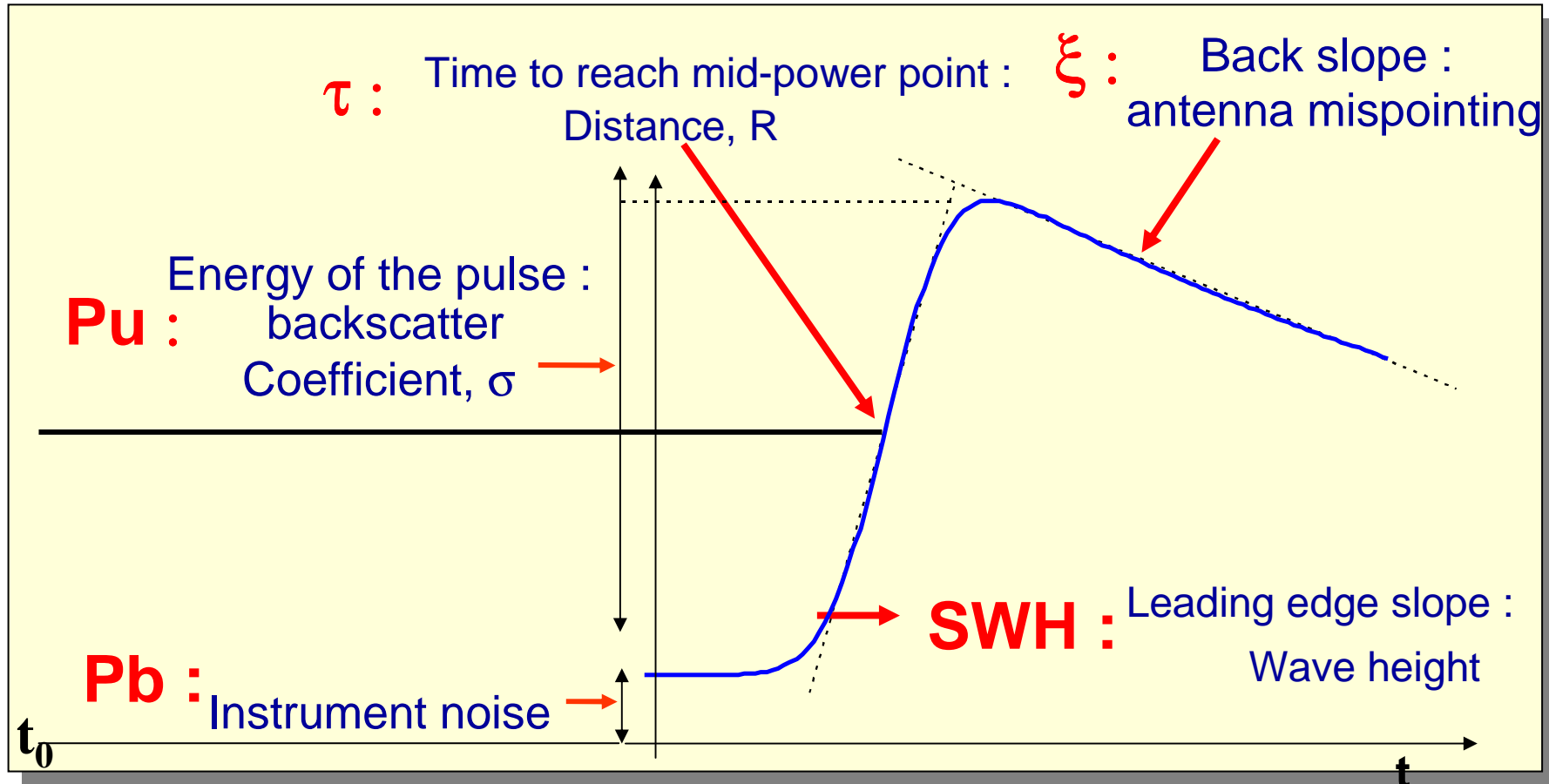

# Wind and wave height estimations

## Significant wave height

is estimated from the change in slope of the wave form's leading edge.

The power of the return signal is related to the wind-induced roughness of the sea-surface. **Wind speed** is then estimated from empirical formulae. Wind direction cannot be resolved.

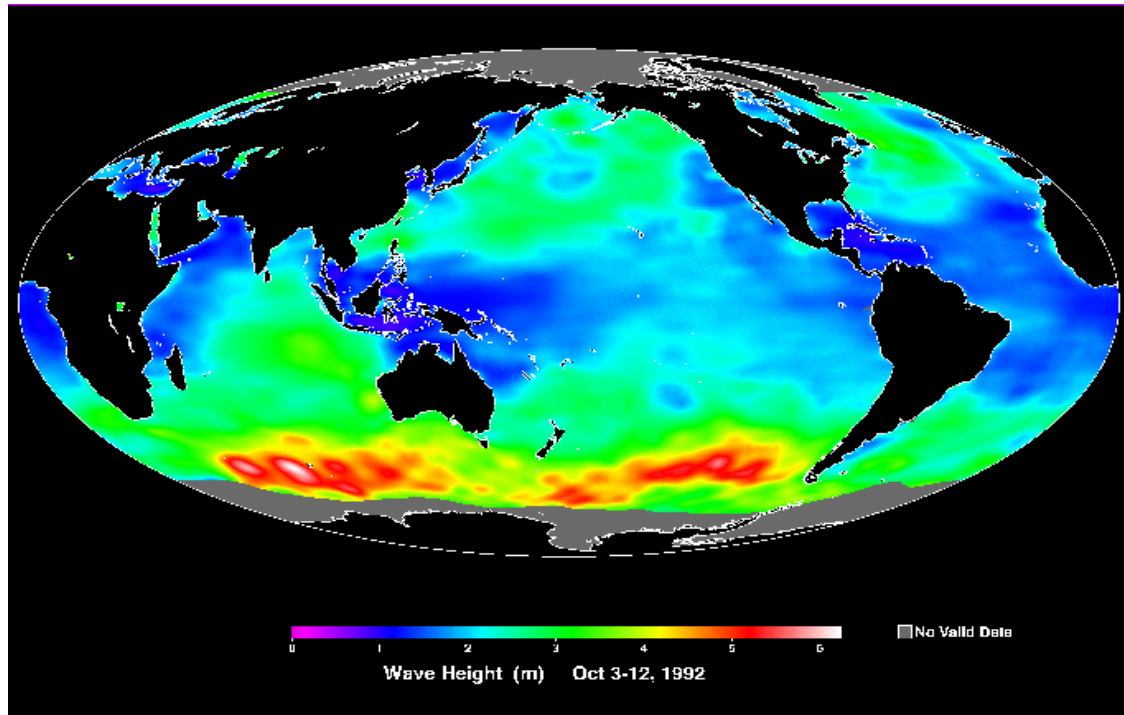



# Other geophysical applications

Analysing the altimeter waveform shape, backscatter coefficient and return power can also be useful tools for determining :

- topographic changes over ice sheets, lakes and rivers, and over desert areas
- for estimating ice and snow thickness.

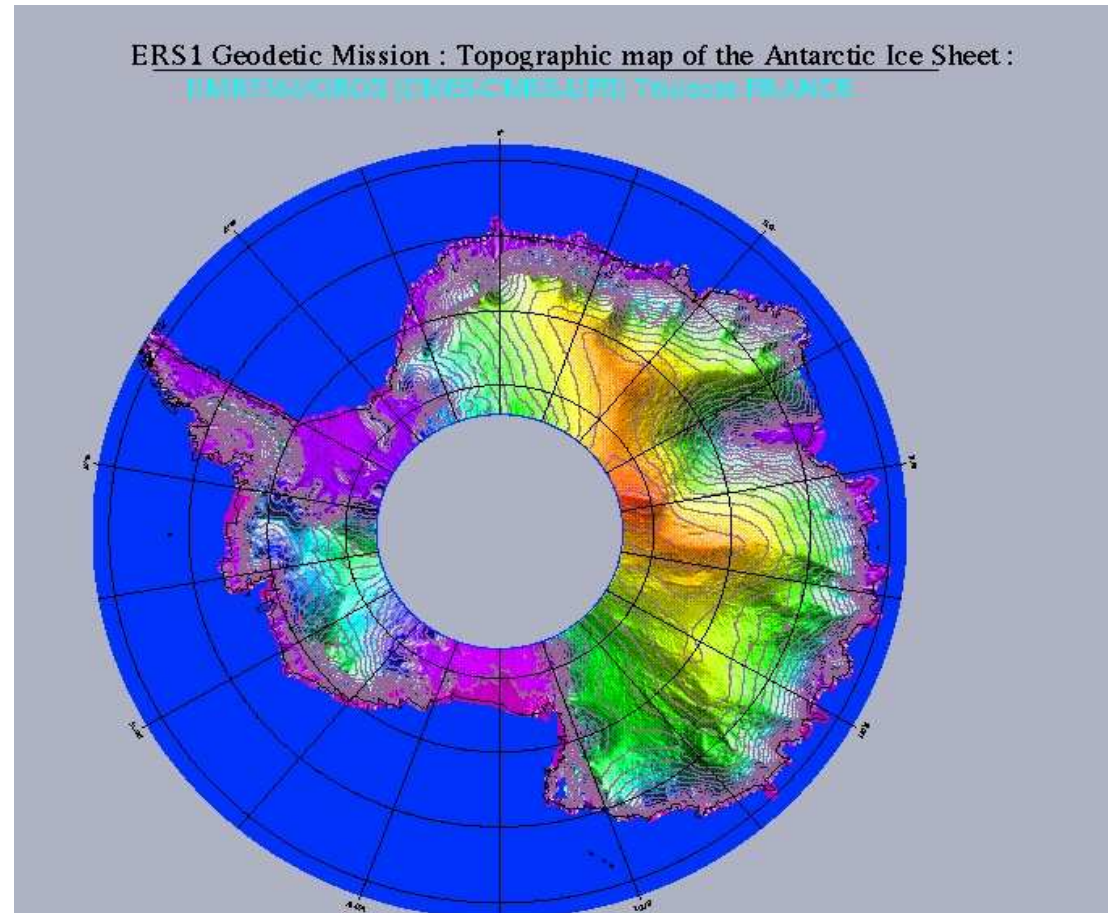

# History of radar altimeters

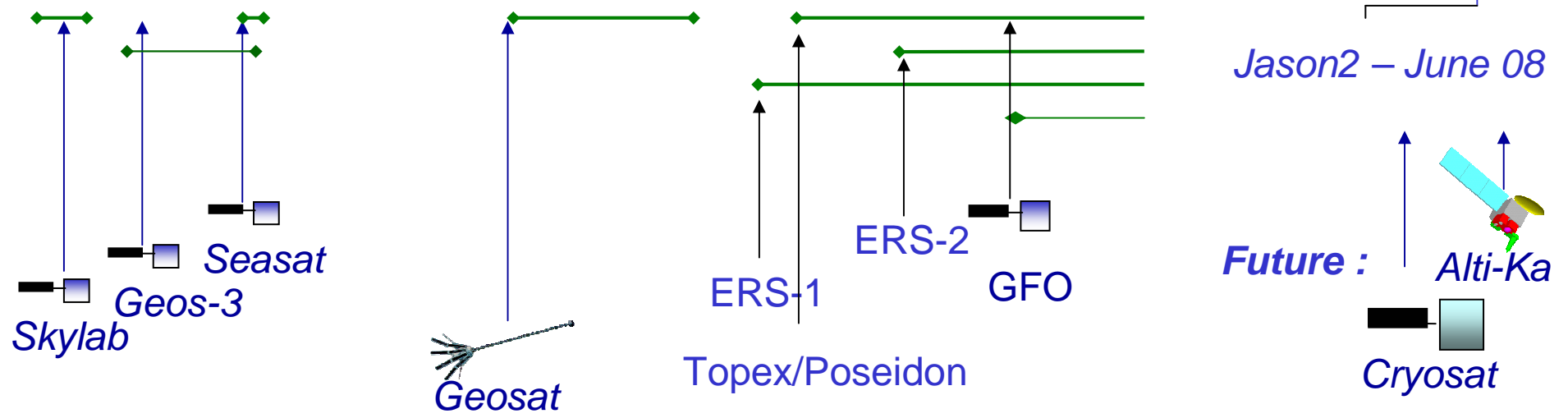
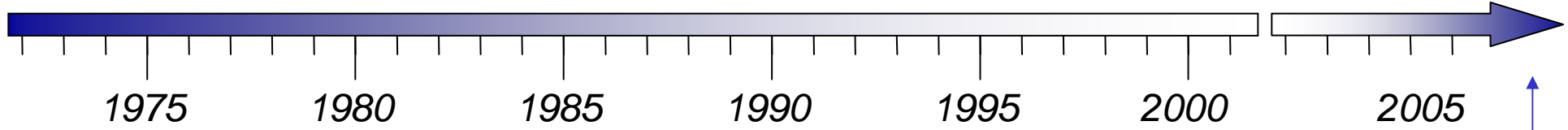
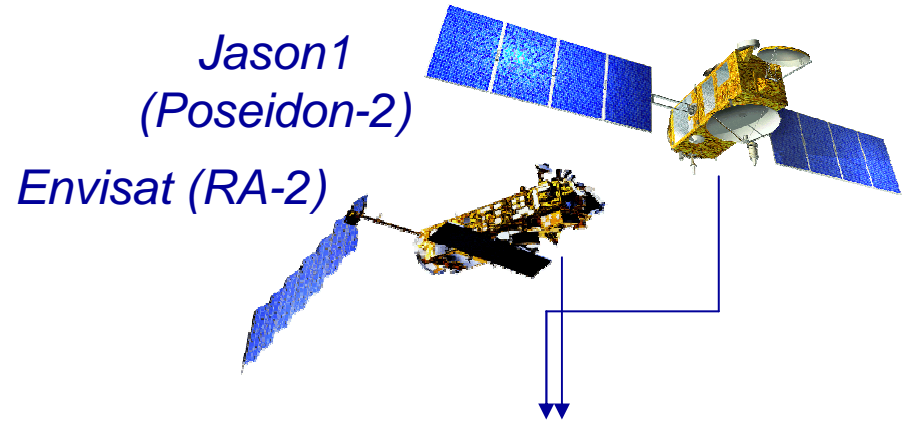

# Mission Parameters

	Geosat	ERS	TOPEX	Poseidon-1	Jason-1	ENVISAT
Altitude	785 km	800 km	1336 km	1336 km	1347 km	800 km
Inclination	108 °	98.5 °	66 °	66 °	66 °	98.55°
Trajectory	Retrograde	Retrograde	Prograde	Prograde	Prograde	Retrograde
Repeat Period	17 days	35 days	10 days	10 days	10 days	35 days
Weight	??	??	219 kg	25 kg	25 kg (x2)	8200 kg (mission) 110 kg
Track Spacing	163 km	77 km	315 km	315 km	315 km	77 km



# Repeat Period and Groundtracks .. 2

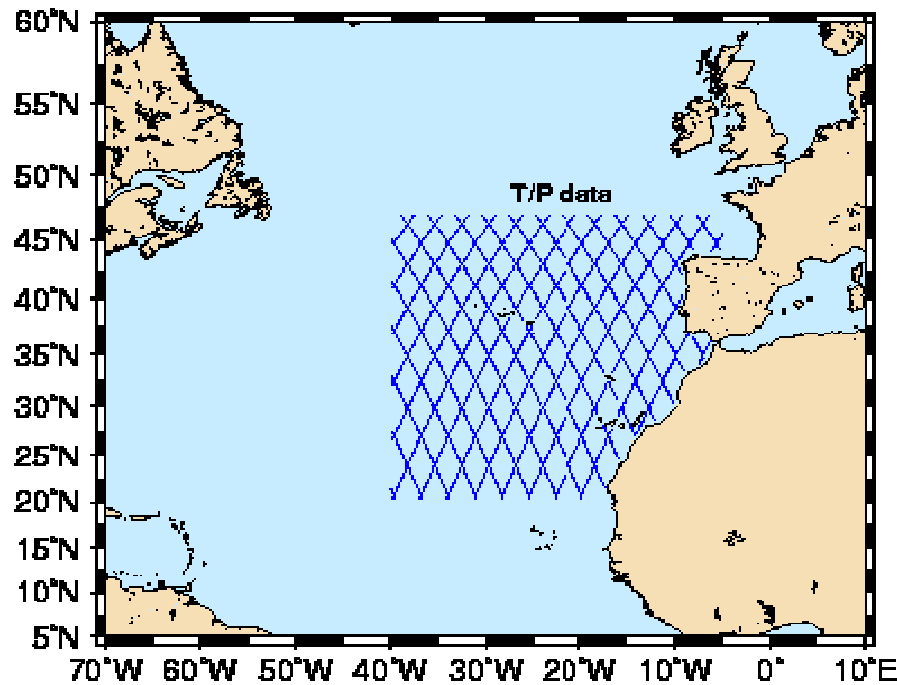

1336 km  
66.03°  
9.915 days 1h52

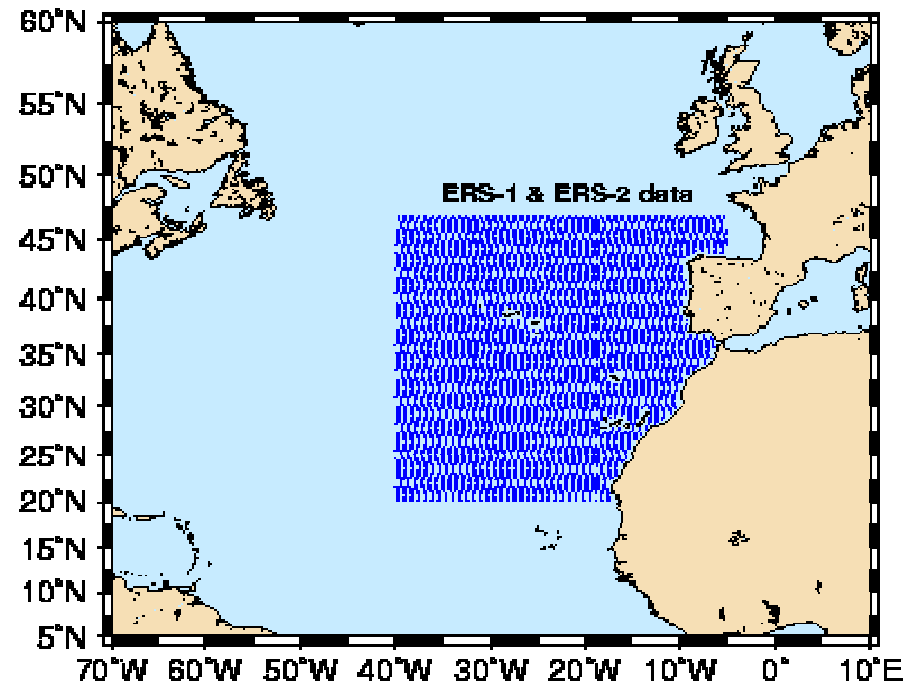

780 km  
98°  
35 days



# Repeat Period and Groundtracks .. 1

The **repeat period** is an integer number revolutions before the satellite comes back to the same ascending node. For a D-day repeat period, the exact repeat period in solar days is :

$$P = 2\pi D / (\Omega' - \theta')$$

i.e. varies with the difference between the precession rate of the orbit plane and the Earth rotation rate.

**Groundtrack spacing** at the equator is given by the orbit inclination,  $i$ , the nodal period,  $D$ , of the exact repeat, and the number of revolutions  $N$  per repeat period. This groundtrack spacing varies as a function of latitude,  $\psi$ :

$$\Delta x = (222.4\pi \cos \psi) / N , \text{ (in degrees)}$$

Any specific combination of  $D$  and  $N$  gives the orbit height.

« Prograde »

« Retrograde »

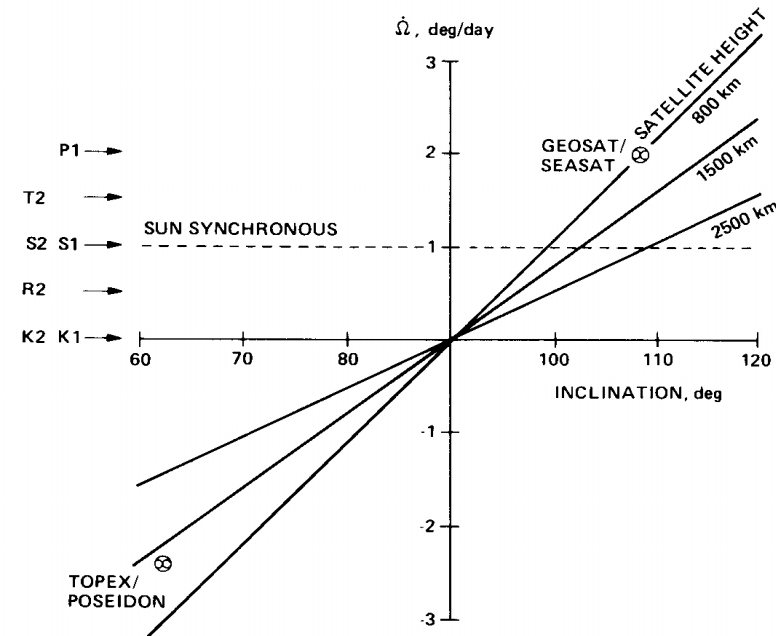

Fig. 7. The precession rate of the orbital plane as a function of inclination, with the altitude of the satellite as a parameter. To avoid aliasing the diurnal (K1, S1 and P1) and semidiurnal (T2, S2, R2, and K2) tides into long periods, orbits which are nearly sun-synchronous should be avoided. The indicated precession rates are those which alias the designated tidal constituent to zero frequency.





# Geophysical parameters, and the corrections

Orbit errors in position of satellite

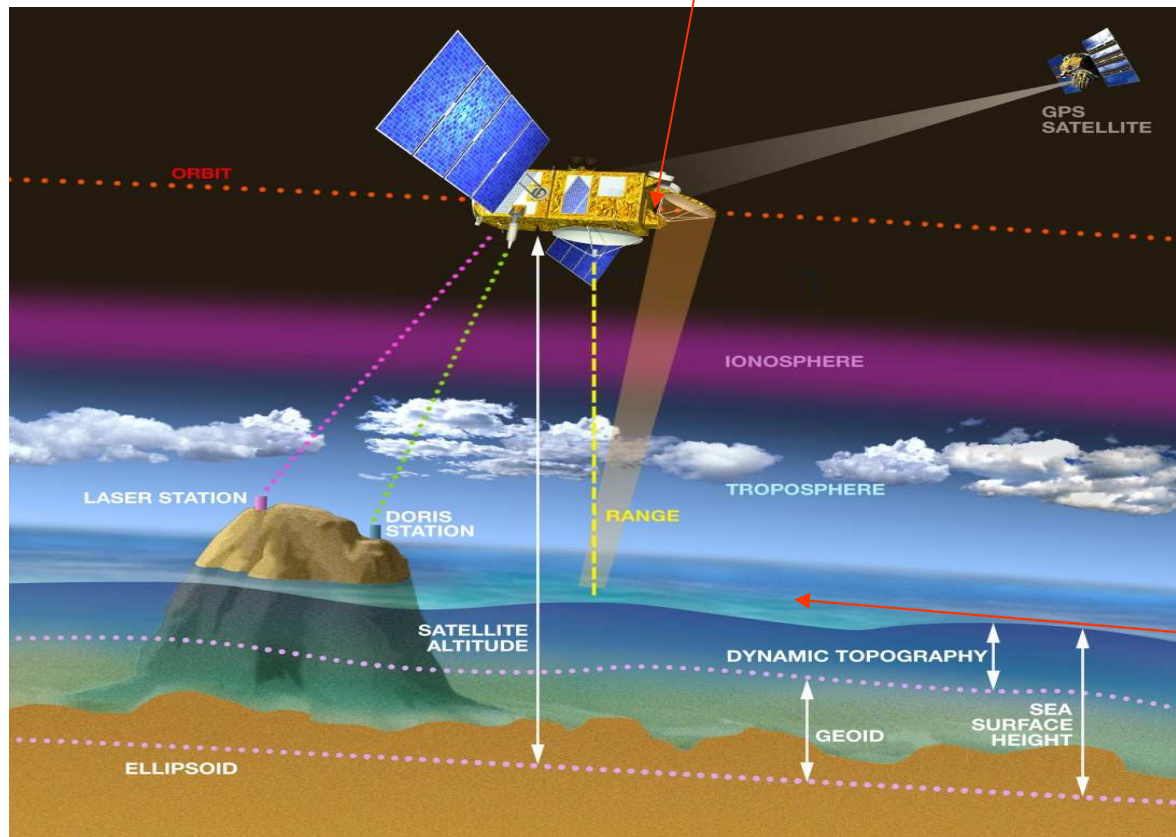

$$\text{SSH} = \text{Altitude} - \text{Range} - \sum \text{Corr}$$

Separating the observed sea surface into ocean dynamic topography and marine geoid



# Orbits

**Precise orbit determination** is made by specialist teams at the space agencies, using:

- **Force perturbation models** on the satellite orbit
- **Orbit tracking systems** : Doris, Laser Tracking, GPS tracking data.



# Perturbation Forces on a satellite orbit

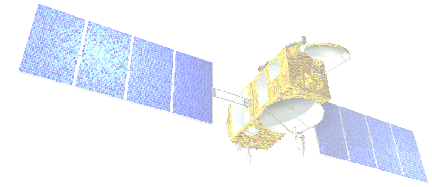

Different forces can perturb a satellite's orbit and these need to be modelled precisely to accurately determine the satellite's position.

## Gravitational Forces:

- the earth's gravity field is not equally distributed – the earth is non- spherical, and gravity varies with the internal density distribution
- gravity perturbations caused by the moving moon, sun and other planets.
- ocean and solid-earth tides

## Forces on the Satellite's surface:

**Atmospheric drag** : depends on the complex shape of the satellite, its surface roughness, and variations in atmospheric density (eg, diurnal and annual solar cycles)

**Radiative pressure** : direct solar radiation, radiation reflected from the earth's surface (albedo effect, varies with cloud cover), earth's IR radiation



# Satellite Tracking Systems ... Laser Tracking and GPS

Satellite tracking is also made using complementary systems : Laser tracking, DORIS and GPS

## Satellite Laser Ranging (SLR).

A network of laser ground stations make direct, precise measurements of the distance between the satellite and the laser ground station.

## GPS

An onboard GPS receiver provides precise, continuous tracking of the satellite by monitoring range and timing signals from up to 6 GPS satellites at the same time.

### Laser Retro-Reflector (LRR)

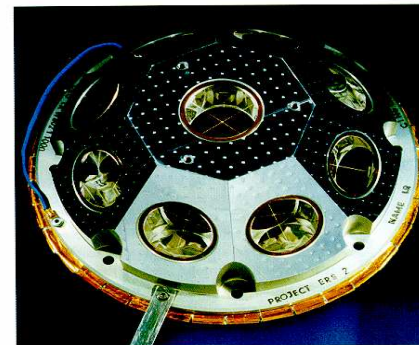
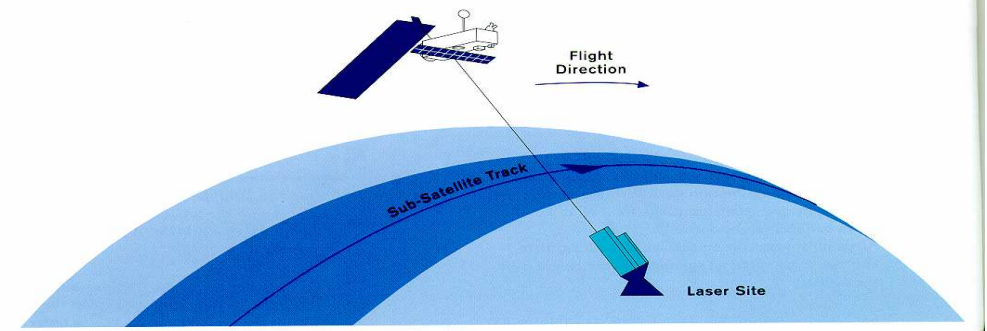

ERS-2 Laser Retro-Reflector  
An identical LRR will be flown  
on ENVISAT-1  
(Photo courtesy of AEROSPATIALE)



# Satellite Tracking Systems ... DORIS

**DORIS** is a Doppler tracking system. A network of DORIS beacons emit 2 signals at different frequencies. An onboard captor measures the Doppler shift between the signals to determine the distance between the satellite and the ground beacon.

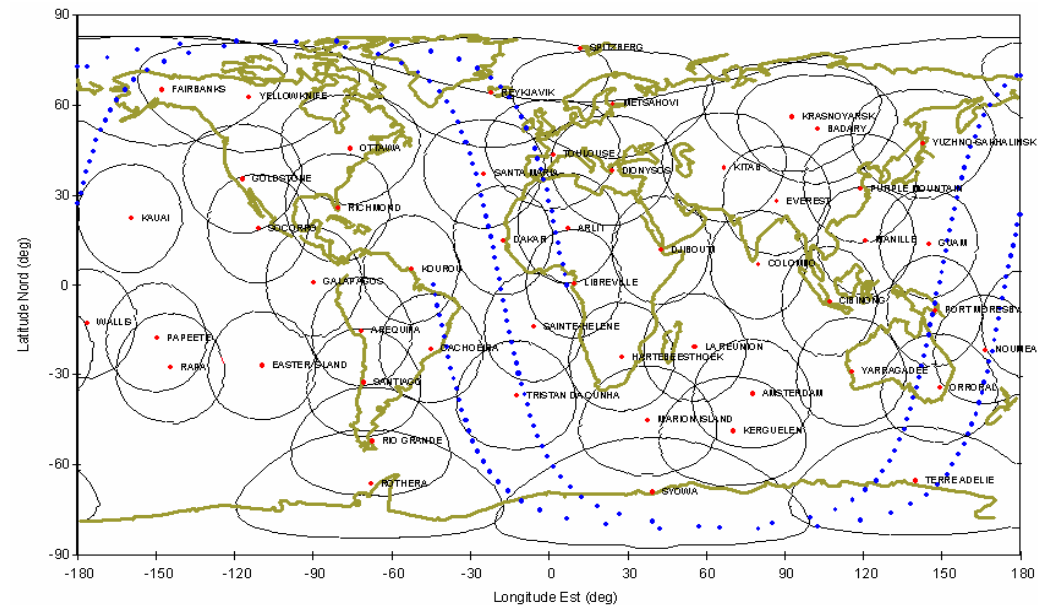



# Instrument and Geophysical Corrections

Instrumental Corrections

$$\text{SSH} = \text{Altitude} - \text{Range} - \sum \text{Corr}$$

Environmental corrections

Sea state corrections

Geophysical corrections

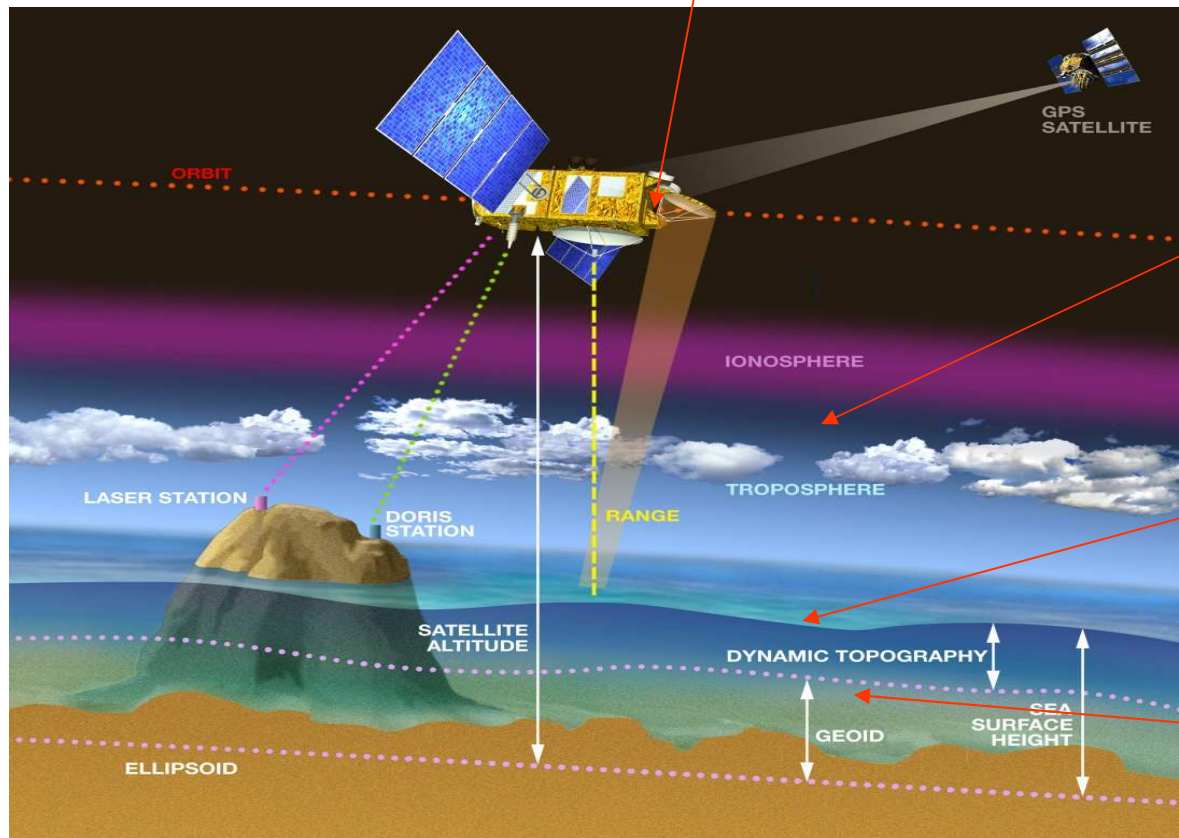

# Instrumental Corrections ... 1

- Oscillator Drift Error :
  - altimeter measures time by counting oscillator cycles
  - Error is due to a drift in the oscillator frequency
  - of ordre 1 cm
- Doppler Shift Effect :
  - due to the relative velocity between the satellite and the sea surface
  - depends on the range rate, and the emitted frequency
  - range errors of + - 13 cm for the Ku band, +-5 cm for C band
- Tracker response error :
  - The on-board tracker does not account for range accelerations
  - largest accelerations occur over deep-ocean trenches
  - correction is a few cms
- Internal Calibration :
  - internal transit time in the altimeter
  - correction is a few cm



# Instrumental Corrections

... 2

- Pointing angle error :
- off-nadir pointing errors effects the two-way travel time
- depends on the pointing angle
- for  $0.2^\circ$  pointing error : 2 cm range error

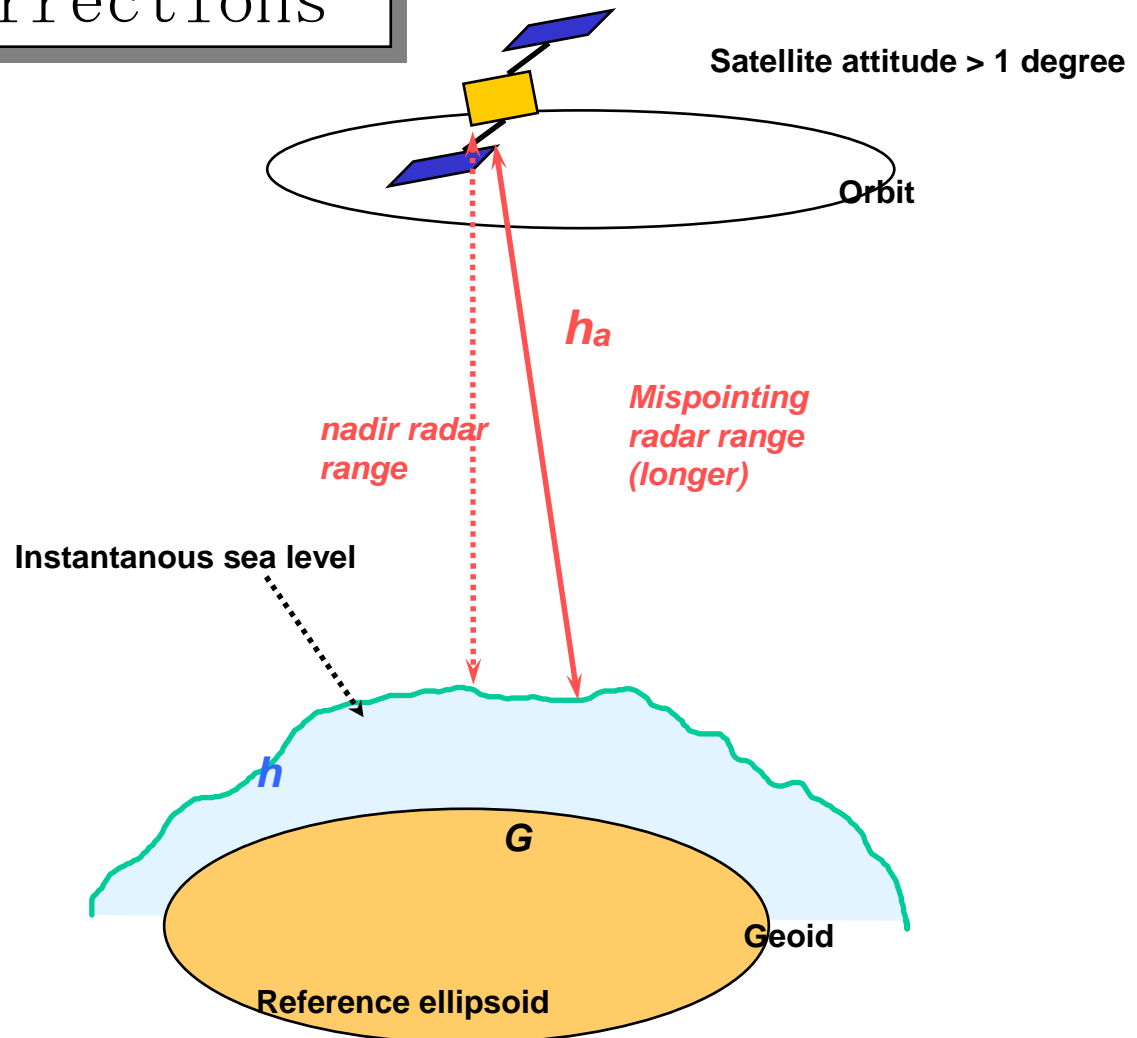

# Range Delay due to Atmospheric Refraction

## Dry Troposphere

The mass of dry air molecules in the atmosphere causes a range delay called the **dry tropospheric** effect. It is directly proportional to the sea level pressure, with an average magnitude of 2.3 m. This correction is computed using atmospheric model pressure forecasts. The error is of the order of 1 cm / 4 mbar, or on average 0.7 cm.

## Wet Troposphere

The range delay due to the atmospheric water vapor, the **wet tropospheric** effect, varies considerably both spatially and temporally, with magnitudes from 5 cm to 30 cm (maximum in the tropical convergence zones, where atmospheric convection is important).

The wet tropospheric correction is computed using either the **on-board microwave radiometer** measurements, with a precision better than 1.4 cm, or the water vapor content is calculated from atmospheric models.



Cycle 170 25-APR-1997 - 05-MAY-1997

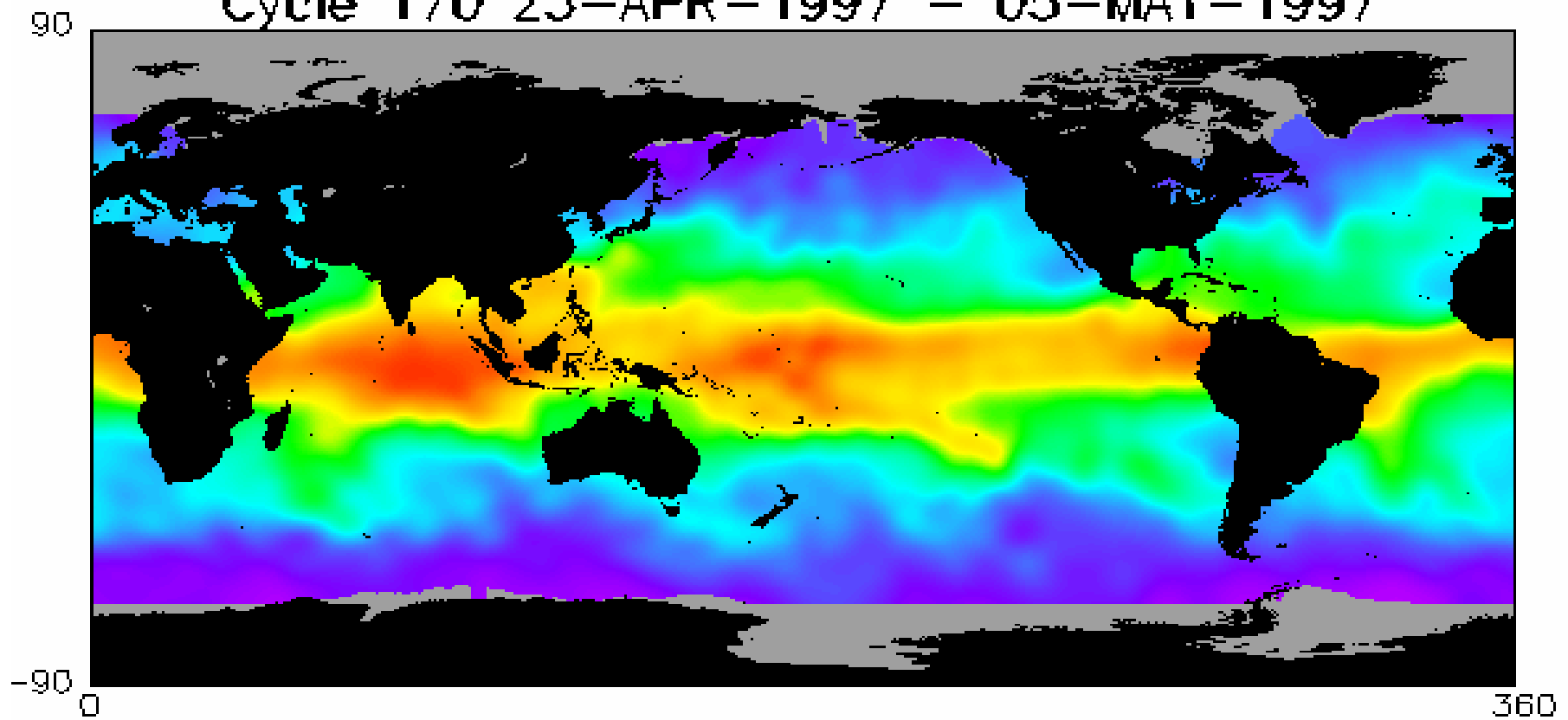

Water Vapor



0.0 1.0 2.0 3.0 4.0 5.0 6.0

Grams per square centimeter

**JPL**

Mon Jun 16 16:51:03 1997



Satellite Oceanography, CICESE, Ensenada. August 2008



# Ionospheric Refraction

- **The radar pulse is delayed in the ionosphere (altitude of 50 - 2000 km) due to the presence of electrons, produced by the ionization in the high atmosphere by the incident solar radiation.**
- **The range delay is related to the EM radiation frequency, so the correction can be estimated using two different radar frequencies (e.g. TOPEX, or DORIS). Otherwise estimated from models of the vertically integrated electron density.**
- **The delay can produce range errors from 1 to 20 cm. The accuracy of the dual-frequency correction is 0.5 cm.**



# Ionospheric Correction - spatial variability

## Spatial distribution

- the Total electron count is mainly correlated to the geomagnetic field, maximum in the tropical band
- the highest electronic perturbation occurs at a 400 km altitude

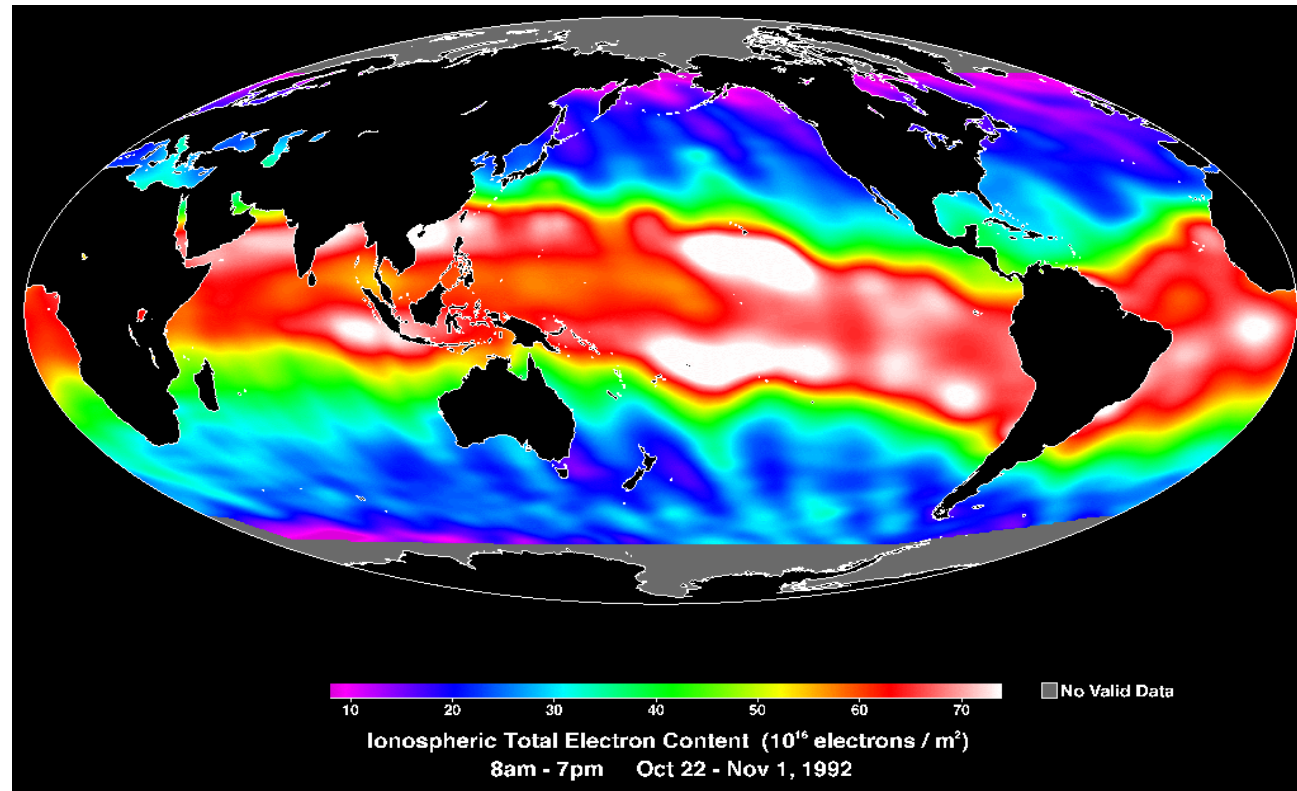

# Ionospheric Correction - temporal variability

## • Temporal variability

- Strongly diurnal, maximum at 2 pm and minimum around 5 am
- the TEC has seasonal variations
- the TEC is correlated with the solar activity, and the geomagnetism

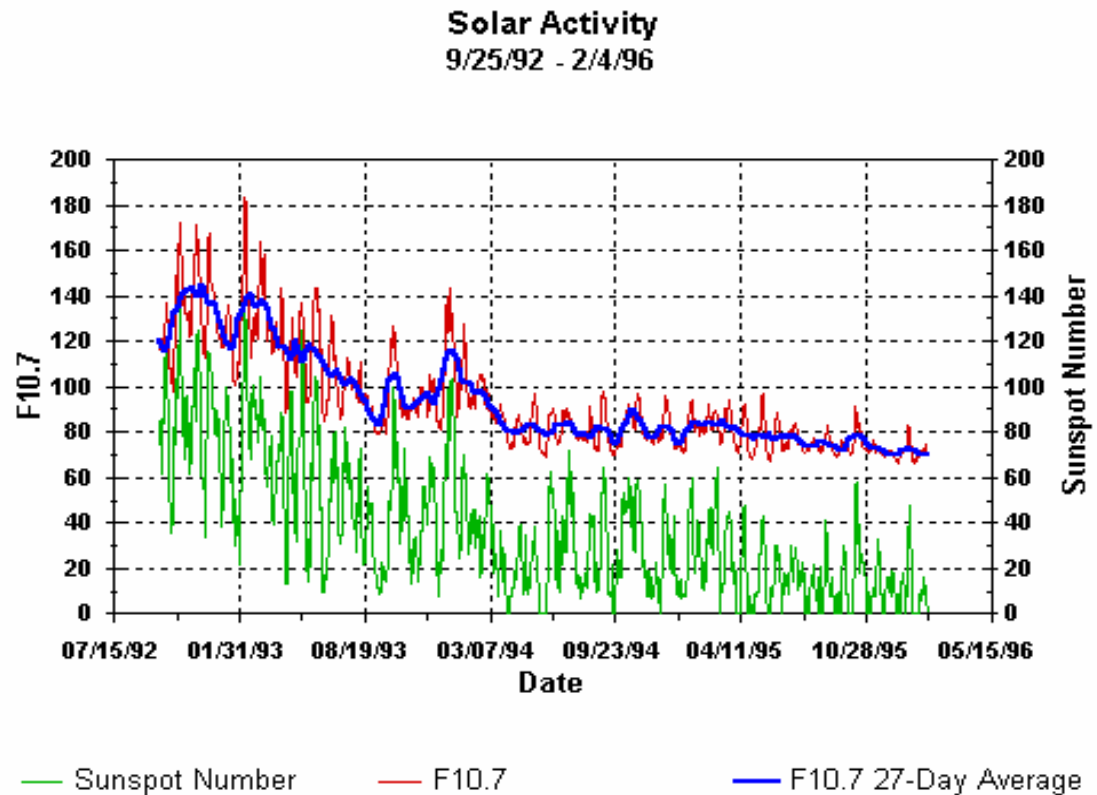

# Sea State Effects

## Electromagnetic bias

The concave form of wave troughs tend to concentrate and better reflect the altimetric pulse. Wave crests tend to disperse the pulse. So the mean reflecting surface is shifted away from mean sea level toward the troughs.

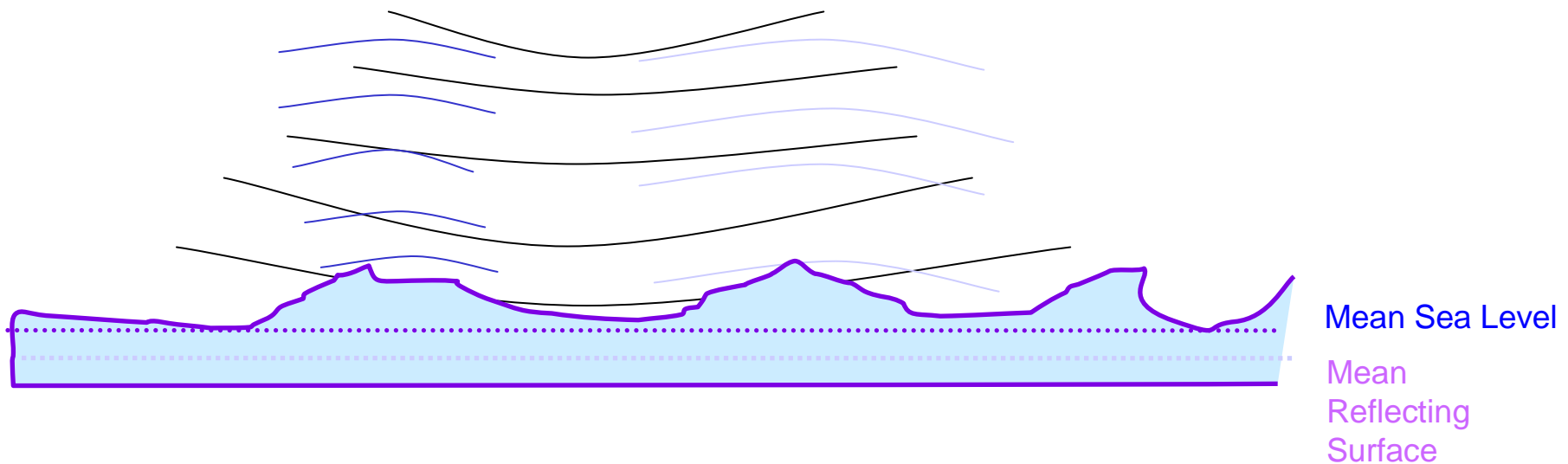

# Sea State Bias

## Skewness bias

For wind waves, wave troughs tend to have a larger surface area than the pointy crests – the difference leads to a skewness bias.

Again, the mean reflecting surface is shifted away from mean sea level toward the troughs

The EM Bias and skewness bias vary with increasing **wind speed and wave height**, but in a non-linear way.

EM bias is estimated using empirical formulas and look-up tables. The range correction varies from a few to 30 cm. EM bias accuracy is ~2 cm, skewness bias accuracy is ~1.2 cm.





# Sea Level components

These geophysical components can all be studied with altimetry.

For precise studies of dynamic topography variations, we need to remove the tides and atmospheric pressure effects : model corrections exist.

**Dynamic sea surface height** : surface currents in geostrophic balance have a sloping sea surface, so the dynamic topography responds to the mean ocean circulation, mesoscale variability, planetary waves, etc. Sea surface height varies by 5 to 30 cm, with slopes of up to 1 m over 100 km (Gulf Stream).

**Ocean Tides** : 10-60 cm in the open ocean, larger amplitudes in coastal regions.

**Atmospheric pressure loading** : increased atmospheric pressure by 1 mbar pushes the sea level down by 1 cm – the isostatic **inverse barometer effect**. However there is also a dynamic response which is not corrected

**High-frequency Barotropic motions** : wind and pressure forcing creates a high-frequency barotropic response at periods < 20 days which is not resolved by 10-day altimeter sampling. Corrected by ocean models.



# Atmospheric Pressure Forcing

*Evolving atmospheric pressure field with highs and lows leads to spatial and temporal variation of the sea level pressure*

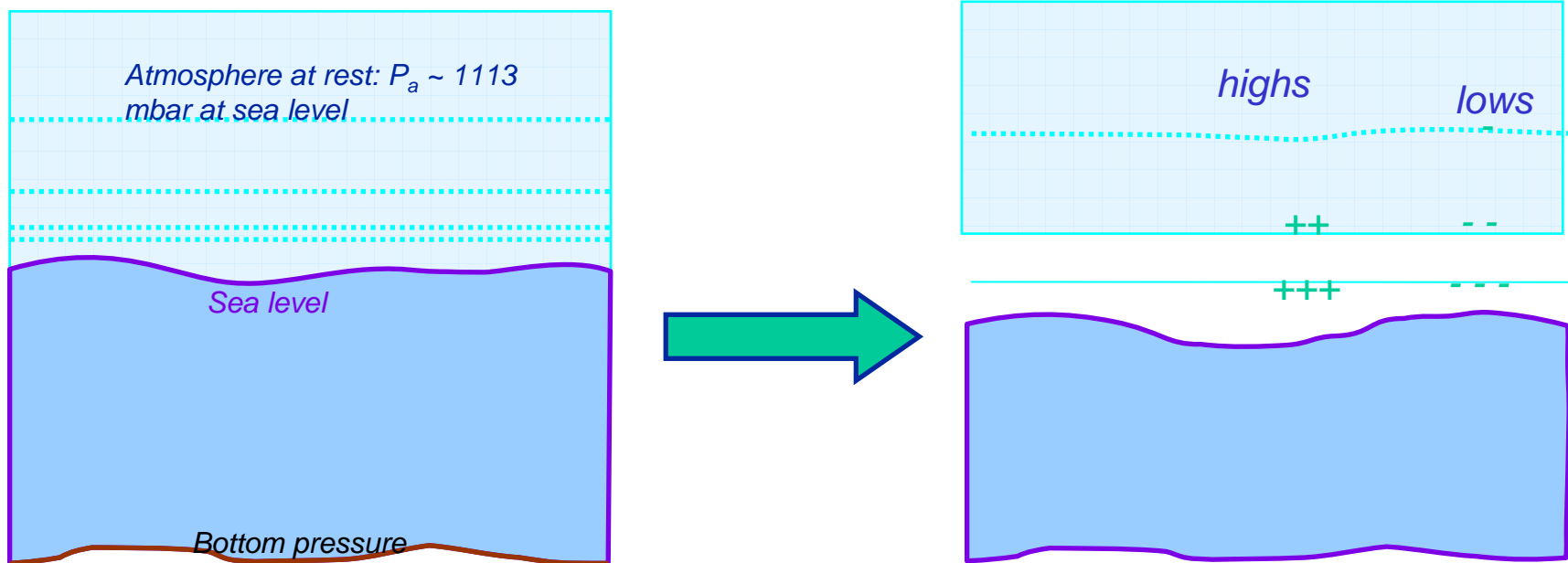

***The ocean responds directly to atmospheric pressure changes: sea level rises (falls) as the low (high) pressure systems pass. At the first order, there is a linear response (the inverse barometer effect) : 1 mbar of relative pressure change leads to a 1 cm sea level change***



# The barotropic response to combined wind and pressure forcing

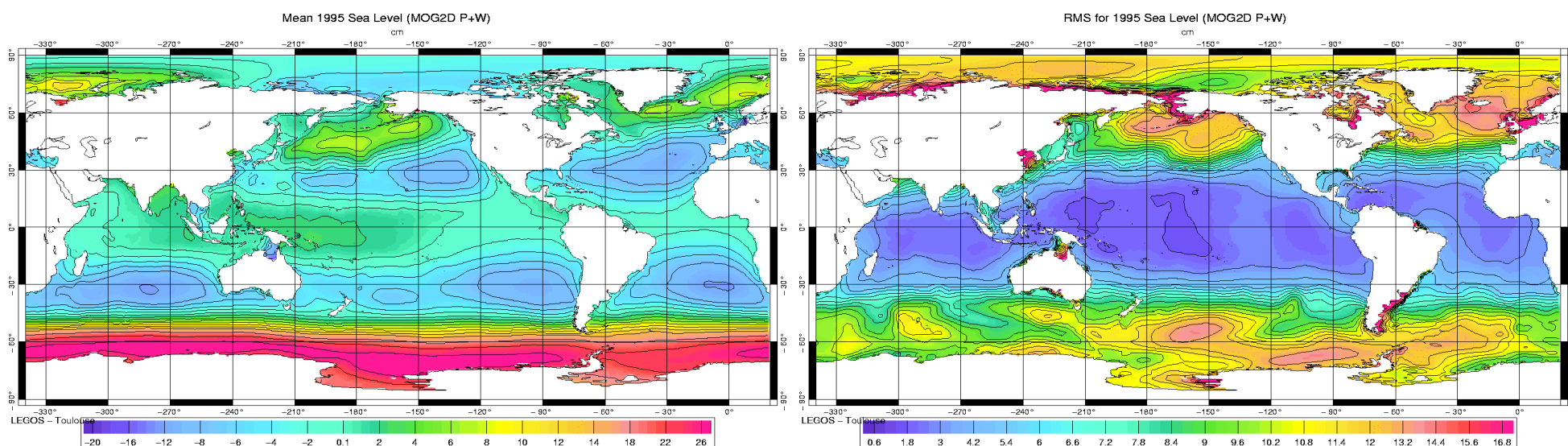

These figures show the mean sea level response (left) and the rms variability of sea level (right) for a barotropic ocean model forced by 6-hourly winds and sea surface pressure. The largest barotropic response (mean and variability) is at higher latitudes, especially in the Southern Ocean. These regions have weak vertical stratification.

In altimetry, this sea level response is mostly at periods < 20 days, and appears as large-scale noise.



# Tides

*The Moon and the Sun generate gravity forces at the Earth surface, which create sea elevations of few meters, which are continuously changing with the Sun and Moon rotations.*

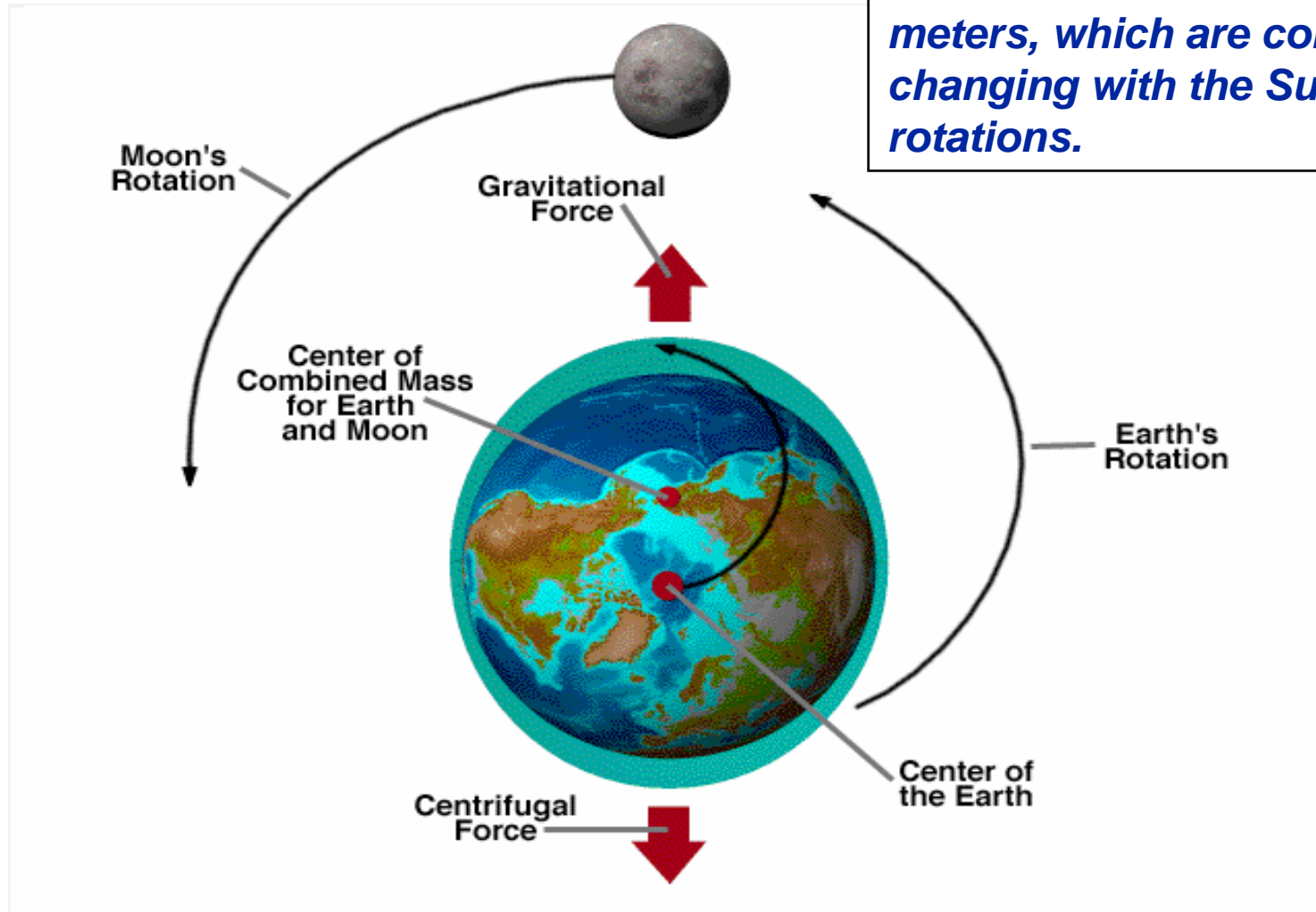

# M2 tide

The main lunar tidal component is the M2 tide. The sum of the major tidal components are modelled (sometimes with altimetry data assimilated) to provide tidal corrections for altimetry.

The figure shows the amplitude (colour) and phase lines (black contours) of the M2 tide, with some time series at different locations.

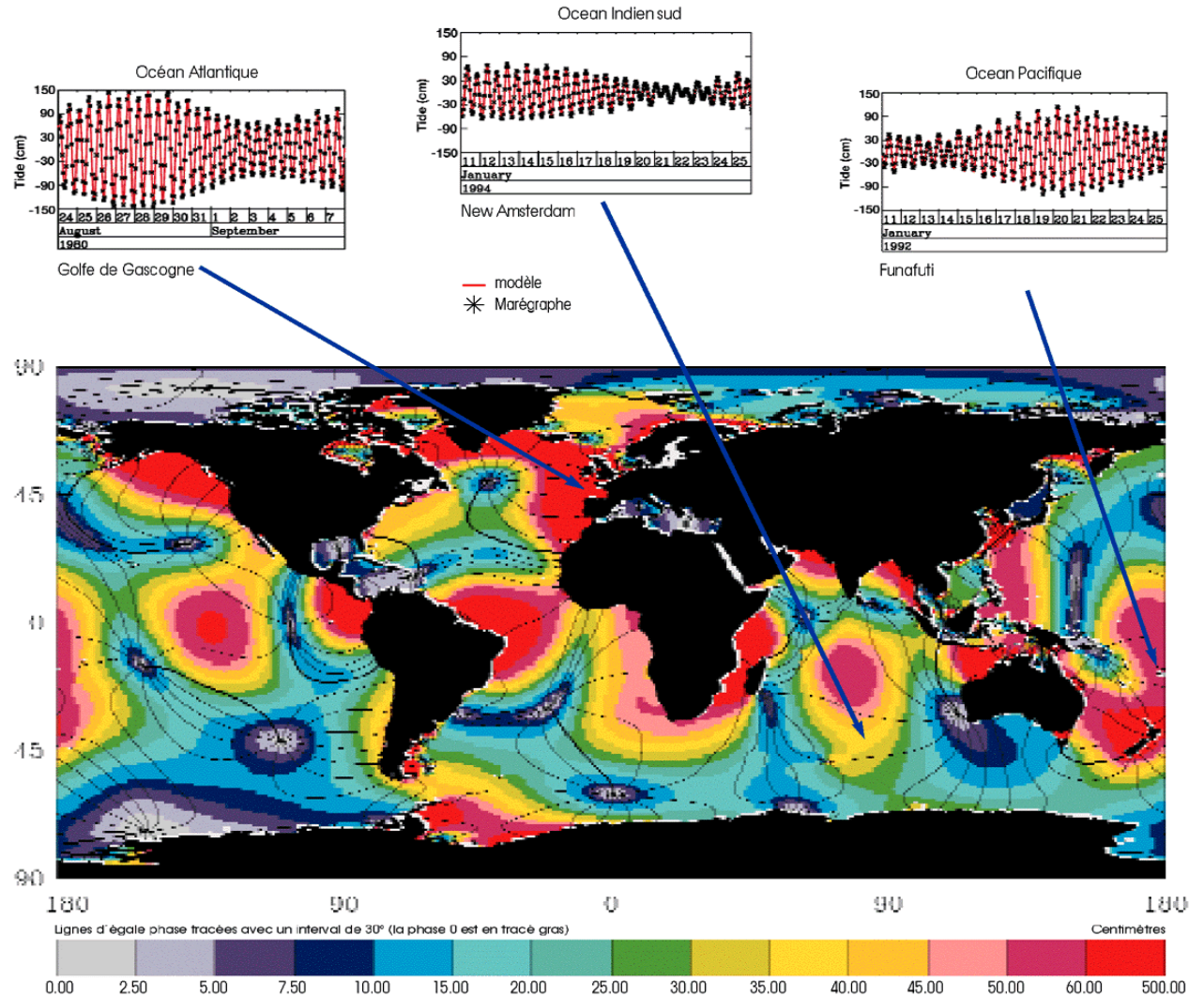



## Tidal Corrections for altimetry data

- Sea level exhibits **ocean tide** perturbations of **5 cm – 10 m**,
- The Earth interior is also perturbed by the Moon and the Sun gravitational attractions, this phenomena is known as the **solid earth tide**: the Earth underneath the ocean is slightly deformed, nearly in phase with the ocean tide (**amplitude ~50 cm**)
- The changing “weight” of the water column due to tides variations generates a **loading effect** on the sea floor (elastic response), causing a **few centimeter** vertical displacement.
- The Earth’s rotation axis deviates slightly from the Earth’s ellipsoid axis over a period of several months, which generates a translation of the Earth ellipsoid with respect to a stationary reference ellipsoid. This causes a **2 cm change** in the relative Earth surface, called the **polar tide**.



# Corrected Altimetric Sea Surface Heights

$SSH = \text{Orbit Altitude} - \text{Range} - \text{corrections}$

$\Sigma$  corrections =

- instrumental noise
- clock accuracy
- mispointing
- sea state bias corrections
- ionospheric correction
- tropospheric corrections (wet, dry)
- Tides + Inverse barometer + HF Barotropic
- **Errors**

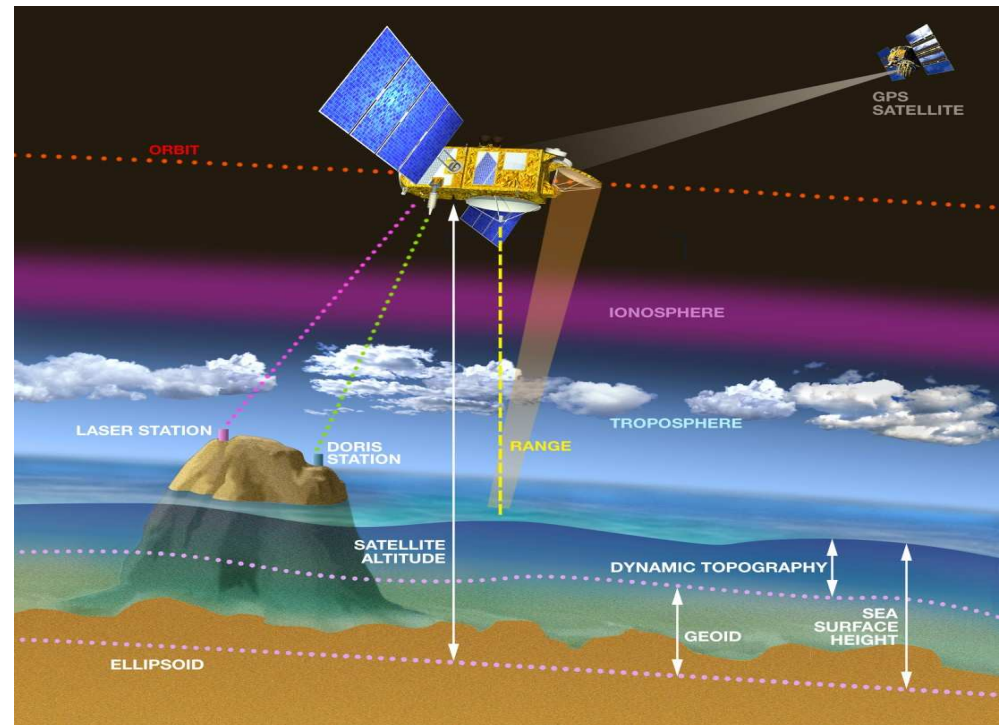

$SSH = \text{Geoid} + \text{dynamic topography}$



Satellite Oceanography, CICESE, Ensenada. August 2008

# Error Budget for altimetric missions

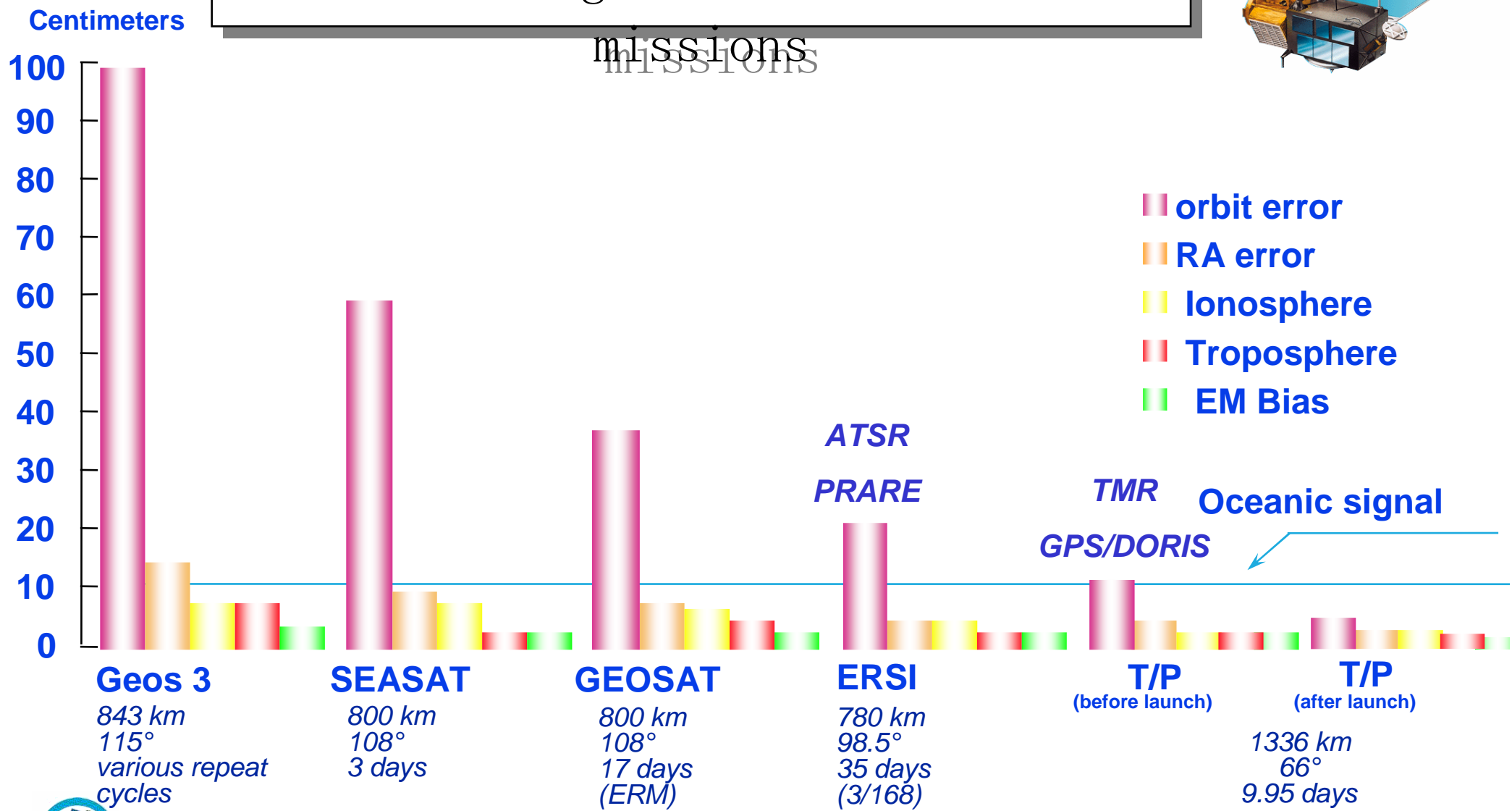
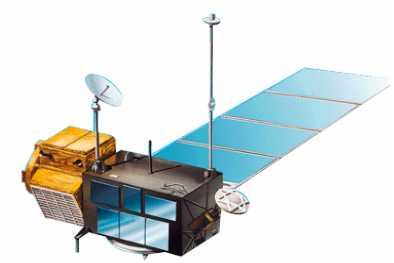

# Status of future altimetry programs

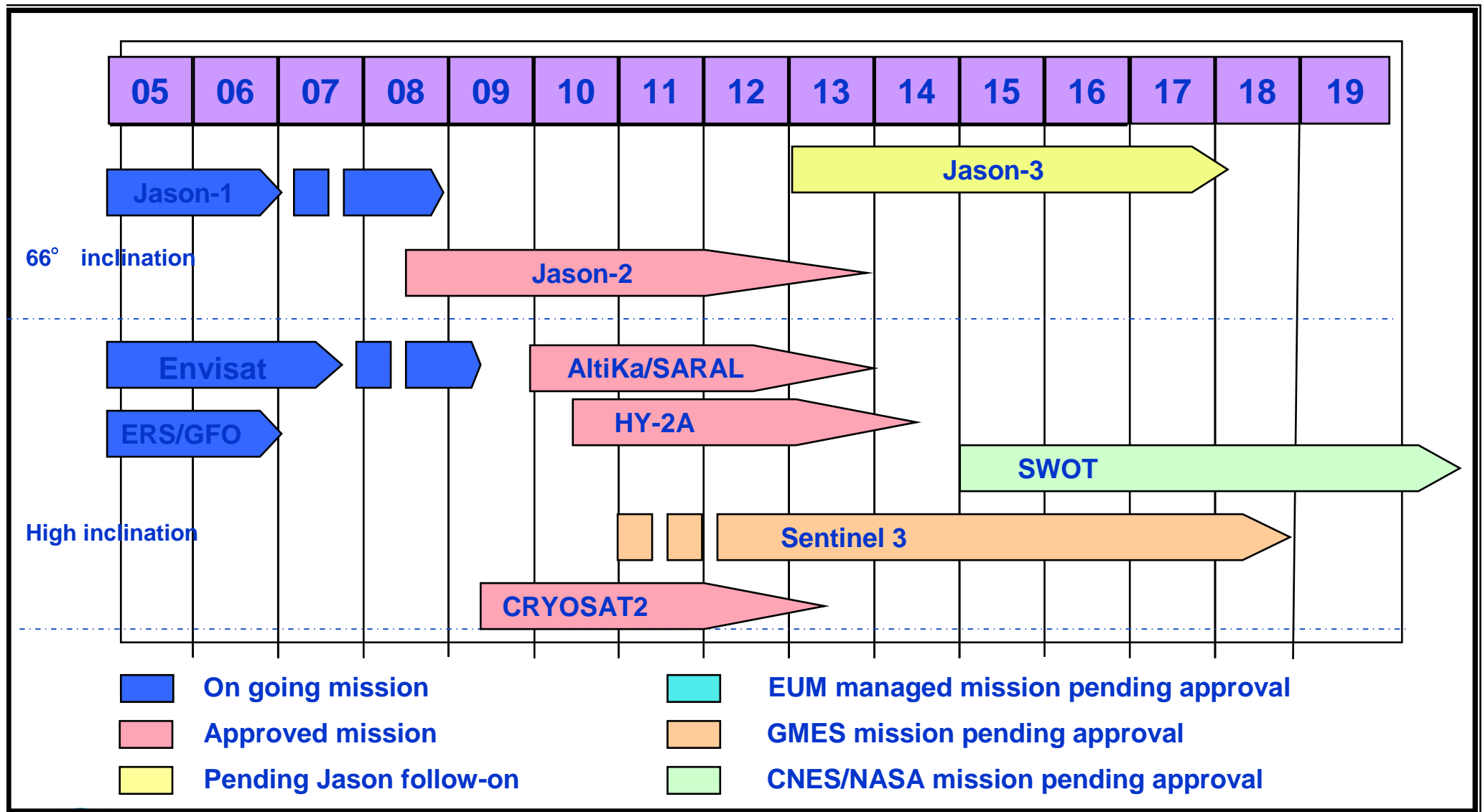

# First look : Jason-2 vs Jason-1 : SLA

Jason-2 : launched 20 June 2008. In its operational orbit in early July, 55 seconds behind Jason-1

SLA for Jason-2 and Jason-1 from first 10 days of data.

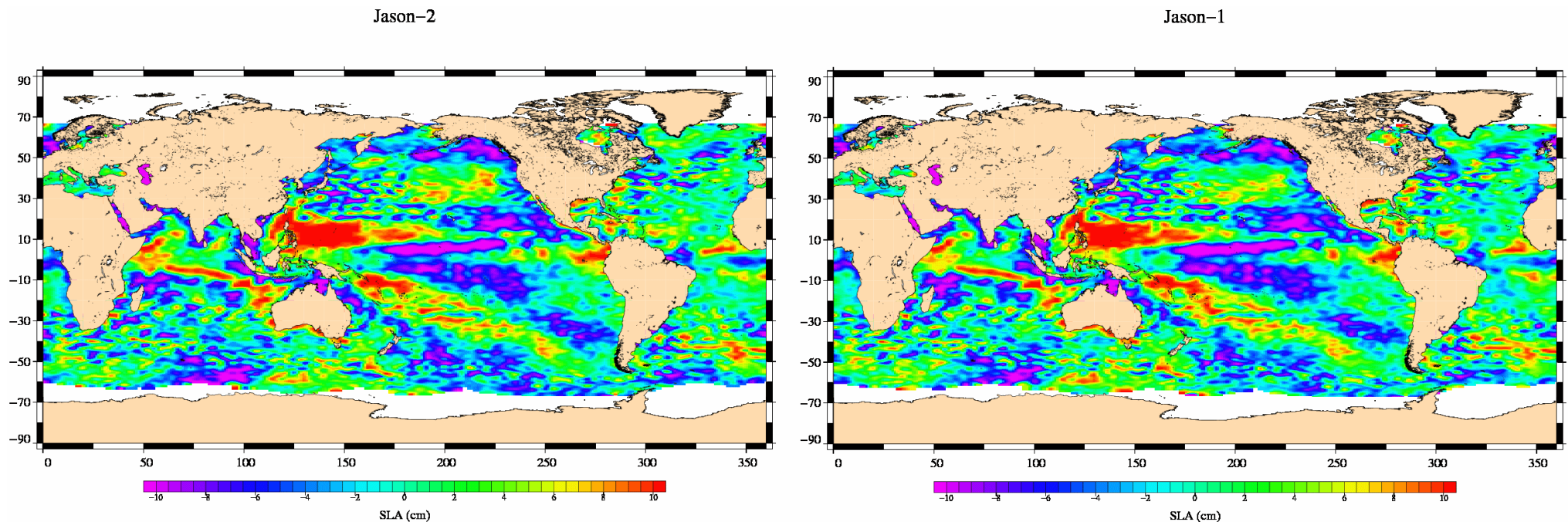



Jason-2

# SWH

Jason-1

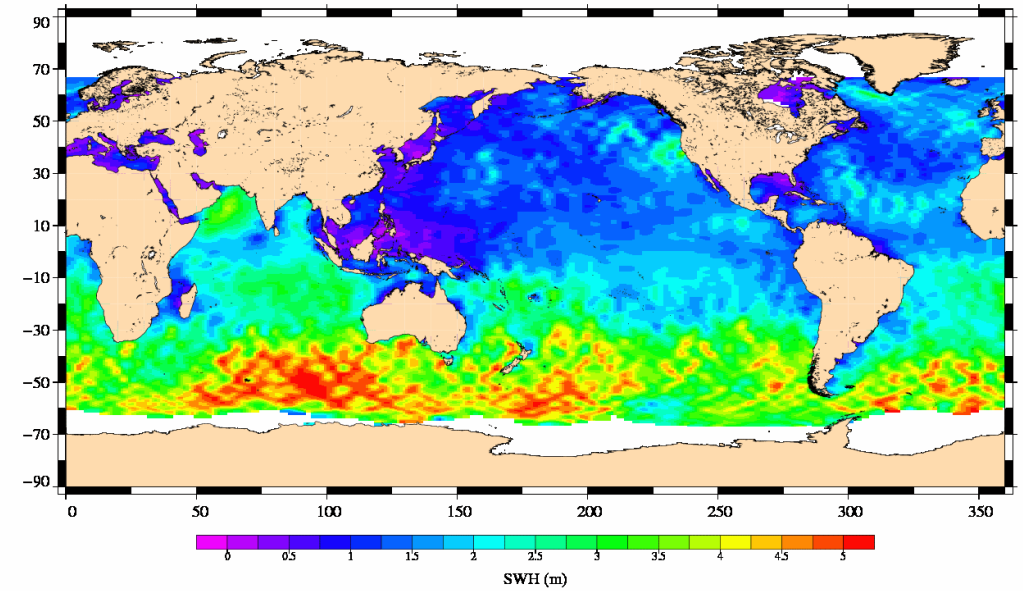
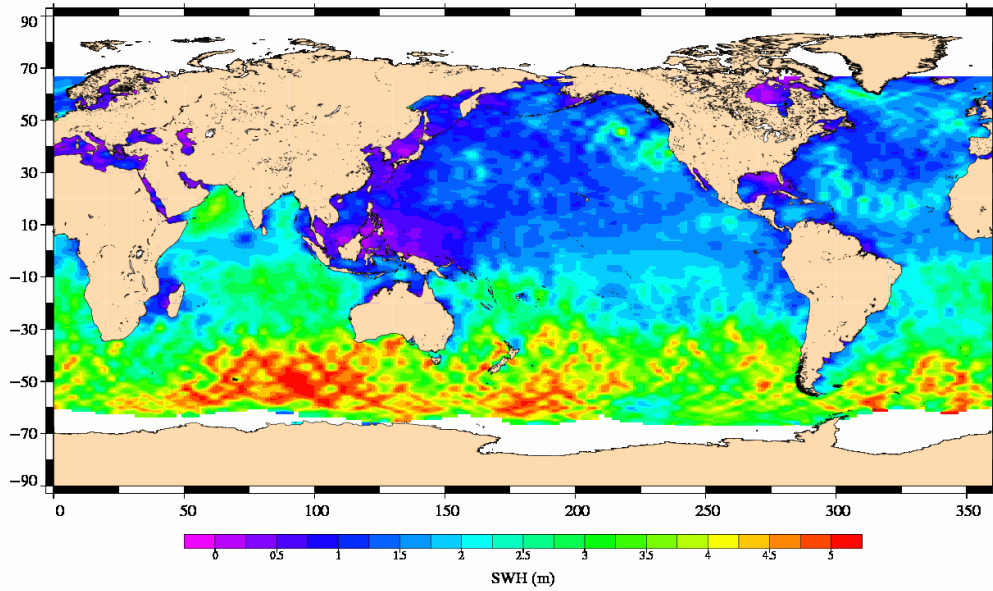

Jason-2

# Wind speed

Jason-1

